

MUGS BY roubill

senator®

designed to brand



MUGS

BY rou bill



0928 APPEAL
> 14-15

0341 PRIME
> 16-17

0968 PURITY
> 18-19

0352 ELITE CHROME
> 20-21

0340 CLUB
> 22-23

0974 CLASSIC COLOUR
> 24-25

0938 DIVA
> 26-27



0960 DIAMOND MUG
> 44-45

0970 FROZEN MUG
0972 FROZEN COLOUR
> 46-47

0975 FROZEN STAR
0976 CLEAR STAR
> 48-49



0750 TROPHY
0751 TITAN
> 56-57

0760 SWING S 0761 SWING M 0762 SWING L
> 58-59

STEEL



0931 + 0932
CARA MIA ESPRESSO
> 62-63

0933 CARA MIA CAPPUCCINO
0934 CARA MIA CAFFÈ LATTE
> 64-65

0977 + 0987
MAXIM ESPRESSO
> 66-67

0907 + 0937
MAXIM CAFÉ
> 68-69

0952 MAXIM START-UP-BOX
0927 MAXIM PLATE
> 70-71



0926 COSMOS
> 28-29

0914 MAXIM
> 30-31

0915 CHARISMA
> 32-33

0912 ELITE
> 34-35

0973 CLASSIC
> 36-37

0344 MAXI MUG
> 38-39

0305 SPECIAL
0911 CULT
> 40-41

PORCELAIN



0980 FROZEN JUICE
0978 FROZEN CUP
> 50-51

0986 CLEAR AQUA
0982 CLEAR AQUA MINI
> 52-53

GLASS



PACKAGING
> 82-83

PACKAGING



0964 + 0984
FANCY ESPRESSO
> 72-73

0965 FANCY CAFÉ SET
> 74-75

0951 FANCY START-UP-BOX
0966 FANCY PLATE
> 76-77

BUSINESS SETS

News



CLASSIC COLOUR 0974

D

Klar, edel und zeitlos im Design, in vielen Varianten, Formen und Farben – die Mugs von rou bill begeistern durch ihre ästhetische Ausstrahlung und Funktionalität. Ob der extra große Kaffeebecher **APPEAL 0928** für einen 0,4 Liter-Trinkgenuss, der farbenfrohe Gute-Laune-Macher **CLASSIC COLOUR 0974** in den neuen Trendfarben Lime und Mokka oder der stapelbare Becher **PURITY 0968**! Alle Mugs haben eines gemeinsam: Sie sind attraktive Multitalente und aufgrund ihrer außerordentlichen Qualität bestens auf die Anforderungen des Alltags vorbereitet.

GB

With a clean, high-quality and timeless design in many variations, shapes and colours – the aesthetic vibrancy and functionality of rou bill mugs will inspire you. No matter whether it is the large **APPEAL 0928** mug with the pleasure of drinking from its 0.4 litre capacity, the colourful feel-good mug **CLASSIC COLOUR 0974** in its new trendy lime and mocha colours, or the stackable mug **PURITY 0968**! All the mugs have one thing in common: They are attractive and multi-talented and thanks to their exceptional quality are perfectly prepared for the challenges of everyday life.

F

Design clair, noble et intemporel. Nombreuses variantes, formes et couleurs – les mugs « rou bill » séduisent autant par leur aspect esthétique que par leur fonctionnalité. Gobelet très grande taille **APPEAL 0928** pouvant contenir 0,4 litre, mug coloré « bonne humeur » **CLASSIC COLOUR 0974** avec ses nouvelles couleurs tendance « Lime » et « Mokka » ou encore gobelet empilable **PURITY 0968** : tous ces articles ont de nombreux points communs : ils sont attrayants, présentent des talents multiples et, de part leur exceptionnelle qualité, satisfont toutes les exigences du quotidien.

NL

Herkenbaar, hoogwaardig en met een tijdloos design, in vele varianten, vormen en kleuren – de mokken van rou bill spreken aan door hun esthetische uitstraling en functionaliteit. Of het nu de mega-mok **APPEAL 0928** met een inhoud van 0,4 liter, de kleurrijke goed-humeur-mok **CLASSIC COLOUR 0974**, in de nieuwe trendy kleuren lime en mokka, of de stapelbare beker **PURITY 0968** is! Alle mokken hebben dit gemeen: ze zijn attractief, voor elke gelegenheid inzetbaar en kunnen op basis van hun buitengewoon hoge kwaliteit iedere uitdaging aan!

**PURITY 0968****APPEAL 0928**



D

SENATOR steht seit 90 Jahren für Qualität, Innovation und Nachhaltigkeit. Das Leitmotiv der Gründer hat noch heute Gültigkeit: „Ideen und Produkte, die anders sind als andere“. Unverändert ist der Innovationsgeist und das Bestreben, immer eine Idee besser zu sein. Dafür greifen wir auf jahrzehntelange Tradition und Erfahrung zurück.

Das Ziel, Ökologie und Ökonomie in Einklang zu bringen, ist bei SENATOR allgegenwärtig. Es wird durch alle Funktionen des Unternehmens hinweg getragen. Im Rahmen eines anspruchsvollen Umweltmanagement-Systems unterziehen wir unsere Prozesse einer regelmäßigen Überprüfung, integrieren neue Erkenntnisse und passen uns wichtigen Veränderungen aktiv an. Daher kommen für unsere Produkte auch nur Rohstoffe zum Einsatz, die einer umfangreichen ökologischen Bewertung standhalten.

Werkstoffauswahl und Produktionsprozesse sind auf Schadstofffreiheit, Verwendung von Recyclingmaterial, biologische Abbaubarkeit und Abfallvermeidung ausgerichtet. Die Einhaltung der REACH-Verordnung der Europäischen Union, die besagt, dass bis 2018 nur noch geprüfte und registrierte Chemikalien verwendet werden, erfüllen wir damit schon jetzt.

Als ISO 9001-zertifiziertes Unternehmen leisten wir nicht nur in jedem einzelnen Bereich geprüfte und verbriefte Qualität, SENATOR verpflichtet sich auch in einem eigens entwickelten SER-Programm (Social & Environmental Responsibility) und im Rahmen der weltweiten „Business Social Compliance Initiative“ (BSCI), in der wir Mitglied sind, ausdrücklich Verantwortung für Menschen und Umwelt zu übernehmen.

Auch bei unseren Mugs by rou bill verpflichten wir uns hohen Qualitätsanforderungen: Alle Dekore auf Porzellan sind gemäß DIN EN 12875-1 spülmaschinen- und kratzfest eingebrannt. Alle Dekore auf Glas und Edelstahl sind spülmaschinengeeignet verarbeitet bzw. eingebrannt. Die Einhaltung der Grenzwerte werden gemäß DIN EN 1388-1 von unabhängigen Sachverständigen geprüft.

GB

SENATOR has stood for quality, innovation and sustainability for 90 years. The guiding principle of the founders still remains valid: “Ideas and products which are different from others”. The spirit of innovation, and the drive to always be one idea ahead remains unchanged. For these purposes we can fall back on decades of tradition and experience.

The goal of conciliating ecology and economy is ingrained throughout SENATOR, and is supported by all functions of the company. As part of an exacting environmental management system, we subject our processes to regular review, integrate new knowledge and actively adapt ourselves to major changes. For our products we only use raw materials which stand up to comprehensive ecological assessment.

Selection of raw materials and production processes are directed towards ensuring the absence of hazardous materials, use of recycled material, bio-degradability and avoidance of waste. We therefore comply with the REACH ordinance of the European Union, which states that only tested and registered chemicals must be used by the year 2018.

As a company certified to ISO 9001, SENATOR not only delivers tested and certified quality in every individual area, but has also committed itself to assume responsibility for people and the environment as part of its own CSR program (Corporate Social Responsibility) and also as member of the worldwide “Business Social Compliance Initiative” (BSCI).

With our Mugs by rou bill, we have also committed ourselves to the most stringent quality requirements: All branding on our porcelain mugs is fired to DIN EN 12875-1 to ensure they are dishwasher- and scratch-proof. Branding on glass and stainless steel is also dishwasher resistance. Our quality control processes are regulated by independent experts in accordance with DIN EN 1388-1.

PEN COLLECTION



MUGS BY roubill



WRITING ACCESSORIES



F

SENATOR est associée à la notion de qualité, d'innovation et de durabilité depuis 90 ans. Le principe directeur des fondateurs de l'entreprise est aujourd'hui encore d'actualité : « Des idées et produits différents des autres ». Rien n'a également changé en matière d'esprit d'innovation et de volonté d'avoir toujours une idée d'avance. Voilà pourquoi nous nous appuyons sur une tradition et une expérience de plusieurs décennies.

L'objectif, à savoir mettre écologie et économie au diapason, est omniprésent chez SENATOR. Il se retrouve dans toutes les fonctions de l'entreprise tel un fil directeur. Nous soumettons nos process à un contrôle régulier, leur intégrons les nouveaux acquis et nous adaptons activement aux changements importants survenus dans le cadre d'un système ambitieux de gestion de l'environnement. C'est pourquoi seules les matières premières jugées aptes dans le cadre d'une évaluation écologique complète entrent dans la fabrication de nos produits.

Le choix des matériaux et les process de production sont basés sur l'absence de substances nocives, l'utilisation de produits recyclés, la biodégradabilité et le moins de déchets possibles. Nous répondons ainsi aux attentes du décret REACH de l'Union Européenne, qui impose l'utilisation exclusive de produits chimiques contrôlés et enregistrés jusqu'en 2018.

En qualité d'entreprise certifiée ISO 9001, SENATOR ne contribue pas seulement à une qualité contrôlée et attestée dans chaque domaine individuel ; en effet, l'entreprise s'engage également, dans un programme SER qu'elle a elle-même initié (Social&EnvironmentalResponsibility) et, dans le cadre de la BSCI mondiale (Business SocialCompliance Initiative), en exprimant ses responsabilités envers l'homme et l'environnement.

Notre engagement porte également sur le respect d'exigences de qualité élevées pour nos « Mugs by roubill » : tous les décors sur porcelaine résistent au lave-vaisselle et aux rayures conformément à DIN EN 12875-1. Les décors sur verre et acier fin sont tous réalisés ou cuits en qualité lave-vaisselle. Quant au respect des valeurs limites, il est contrôlé selon DIN EN 1388-1 par des experts indépendants.

NL

SENATOR staat al 90 jaar garant voor kwaliteit, innovatie en duurzaamheid. Het motto van de oprichters heeft nog niets aan geldigheid ingeboet: 'Ideeën en producten die anders zijn dan de andere'. De zin voor innovatie en de doelstelling om altijd een beter idee te hebben, is onveranderd. Daarbij grijpen wij terug op tientallen jaren traditie en ervaring.

Het doel om ecologie en economie met elkaar te verzoenen, is bij SENATOR alom tegenwoordig. Het wordt in alle geledingen van de onderneming gesteund. In het kader van een veeleisend milieumanagementsysteem onderwerpen wij onze processen aan regelmatige controles, integreren nieuwe inzichten en passen ons actief aan belangrijke veranderingen aan. Daarom worden voor onze producten ook uitsluitend grondstoffen gebruikt die een omvangrijke ecologische beoordeling hebben doorstaan.

De selectie van materialen en productieprocessen is op de afwezigheid van schadelijke stoffen, het gebruik van recyclingmateriaal, biologische afbreekbaarheid en afvalvermindering afgestemd. De naleving van de REACH-verordening van de Europese Unie, die zegt dat vanaf 2018 uitsluitend nog geteste en geregistreerde chemicaliën gebruikt mogen worden, is bij ons nu al een feit.

Als ISO 9001-gecertificeerde onderneming leveren wij niet alleen in elk afzonderlijk gebied geteste en schriftelijk vastgelegde kwaliteit, SENATOR verbindt zich er ook toe via een eigen ontwikkeld SER-programma (Social&EnvironmentalResponsibility, Sociale en ecologische verantwoordelijkheid) en in het kader van het wereldwijde, Business SocialCompliance Initiative' (BSCI), uitdrukkelijk verantwoordelijkheid voor mens en milieu te nemen.

Ook bij onze Mugs by roubill verbinden wij ons aan strenge kwaliteitsnormen: alle versieringen op porselein zijn volgens DIN EN 12875-1 vaatwasbestendig en krasvast ingebrand. Alle versieringen op glas en roestvrij staal zijn vaatwasbestendig verwerkt of ingebrand. De naleving van de grenswaarden wordt volgens DIN EN 1388-1 door onafhankelijke deskundigen gecontroleerd.



LOGO 4U



D

Wir kommunizieren Ihre Werbebotschaft. Unser Erfolgsrezept? Erfahrung, Innovation und Können. Mit LOGO 4U verleihen wir Ihrem Logo Tiefe und Struktur. rou bill präsentiert die neue Generation der Tassenveredelung. Logogravur ist der Schlüssel dazu: Logos und Botschaften werden mit LOGO 4U direkt in die Mug-Oberfläche gestrahlt. Slogans können so mit den Fingern erkundet werden. Die Räumlichkeit des Logos wird perfekt durch das COLOUR 4U Verfahren ergänzt.

GB

We convey your advertising message. Our recipe for success? Experience, innovation and expertise. With LOGO 4U, we give your logo depth and structure. rou bill presents the new generation of mug finishes. Logo engraving is the key: Logos and messages are blasted directly into the mug surface with LOGO 4U. Users can thus feel the logo with their fingers. The logo space is perfectly supplemented by the COLOUR 4U process.

F

Nous nous chargeons de transmettre votre message publicitaire. Les clés de notre succès? Notre expérience, notre esprit novateur et notre savoir-faire. Grâce à LOGO 4U, nous conférons du relief à votre logo, une élégance délectable. rou bill présente la toute nouvelle génération d'affinage pour vos tasses. La recette: la gravure de logos. Grâce à LOGO 4U, vos logos et vos messages sont gravés directement sur la surface du mug. Ainsi, vos slogans peuvent également être découverts par le toucher. Le procédé COLOUR 4U permet de mettre encore davantage en exergue votre logo.

NL

Wij brengen uw reclameboodschap over. Ons recept voor succes? Ervaring, innovatie en kunde. Met LOGO 4U geven we uw logo diepte en structuur. Rou bill presenteert de nieuwe manier van het veredelen van mokken. De zandstraal techniek is daarbij de sleutel: logo's en boodschappen worden met LOGO 4U in het oppervlak van de mok gezandstraald. Slogans en aanbevelingen worden zo voelbaar. Het ruimtelijk effect van het logo wordt nog beter zichtbaar in combinatie met COLOUR 4U.

COLOUR 4U



D

Der Bedeutung von Corporate Design sind wir uns sehr bewusst. Entsprechend erstklassig haben wir uns in der Produktion aufgestellt – für ein optimales Ergebnis! Die Tassen erstrahlen in Ihrer Hausfarbe: kein Standard, alles individuell. Mehr Farbe und mehr Wirkung inklusive. COLOUR 4U ist natürlich auch mit anderen Veredelungsoptionen kombinierbar. Höchste Qualität inklusive Kratz- und Spülmaschinenfestigkeit garantiert. Und das alles schon ab einer Auflage von 108 Stück. LOGO 4U und COLOUR 4U – ein perfektes Team für Ihren Werbeerfolg!

GB

We are well aware of the importance of corporate design. We have organised our first class production processes to reflect this – and achieve optimum results! The mugs shine with your company colour: Nothing standard, totally individual. More colour and more impact is part of the package. COLOUR 4U can also be combined with other finish options. Top quality, including scratch and dishwasher resistance, is guaranteed. And all of that with an orders of just 108 mugs. LOGO 4U and COLOUR 4U – a perfect team to make your advertising a success!

F

La réalisation du « Corporate Design » au plus haut niveau nous tient à cœur. Par conséquent, notre production s'avère très compétitive, pour un résultat optimal! Nous créons une osmose entre le coloris de vos tasses et celui de l'intérieur de votre habitation. Notre mot d'ordre: la personnalisation prime! En bonus: davantage de couleur et davantage d'effet. COLOUR 4U peut, bien évidemment, être combiné à d'autres options d'affinage. Excellente qualité, résistance aux rayures et résistance au lave-vaisselle garanties...dès 108 exemplaires. LOGO 4U et COLOUR 4U constituent une équipe soudée qui contribuera à votre succès publicitaire!

NL

We zijn ons zeer bewust van de betekenis van Corporate Design. Daarop is onze productieafdeling dan ook optimaal ingesteld – voor het best mogelijke resultaat! De mokken stralen in de huisstijlkleur: niet standaard, maar individueel. Kleurrijker en met meer effect. COLOUR 4U is natuurlijk ook uitstekend te combineren met andere veredelingsmogelijkheden. Topkwaliteit, inclusief krasvastheid en vaatwasmachine bestendigheid zijn vanzelfsprekend. En dat al vanaf een oplage van 108 stuks – uniek in Europa. LOGO 4U en COLOUR 4U – een perfecte combinatie voor uw succesvolle reclame!

PAPERPROOF

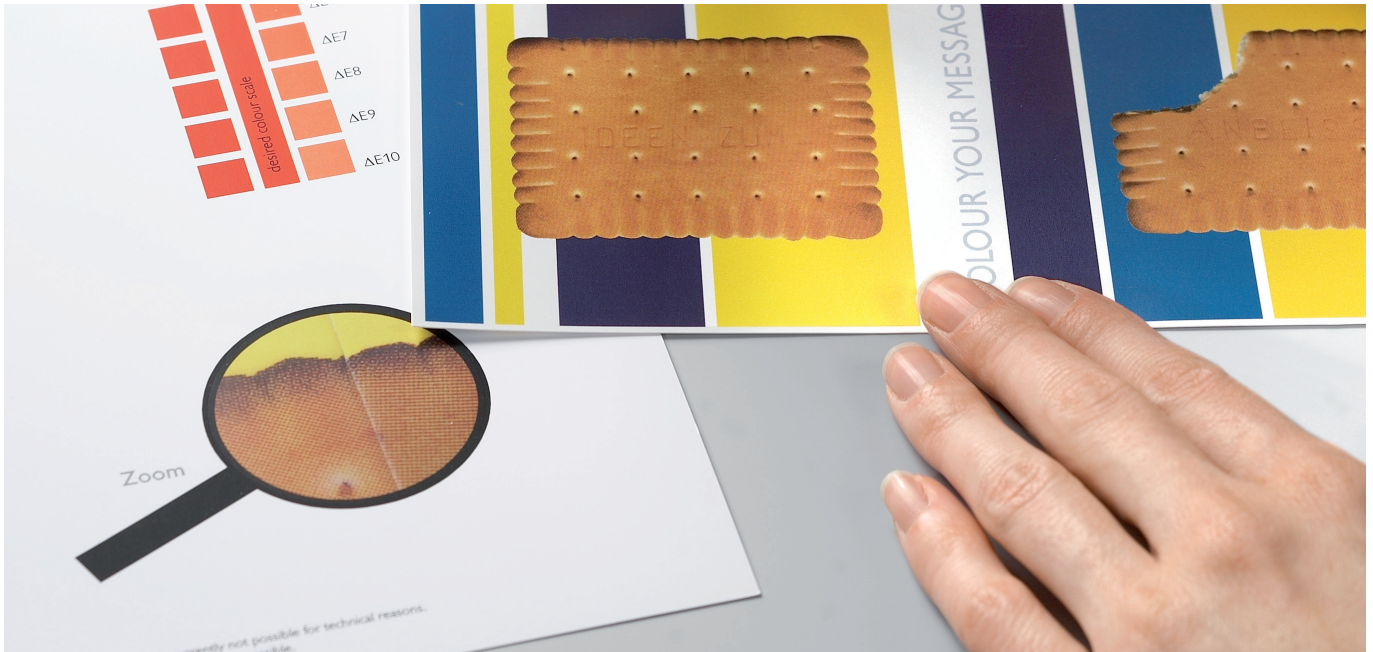

D

Neugierig auf das Endergebnis? Mit PAPERPROOF erhalten Sie einen Vorabzug für alle Ideen, die später auf Porzellantassen und -tellern realisiert werden sollen. Auch ohne die Vorab-Produktion eines Ausfallmusters können Sie einen farbverbindlichen Proof in den Händen halten. Dieser gelangt innerhalb von 48 Stunden zu Ihnen. Eine kostenreduzierende Lösung – komfortabel und einfach.

F

Curieux du résultat final? Grâce au procédé PAPERPROOF, rou bill est en mesure de vous fournir un aperçu avant impression de grande qualité sur papier. Il s'agit ici d'une impression préliminaire de vos idées en vue de leur réalisation ultérieure sur tasses ou assiettes en porcelaine. Il n'est ainsi plus nécessaire de demander d'échantillon-modèle: une impression respectant les couleurs choisies vous est remise. Dans les 48 heures après réception de la commande, vous recevrez rapidement et sans complication l'épreuve d'impression en couleur. Voici une solution facile qui permet de réduire vos frais.

GB

Curious about the end result? With PAPERPROOF you receive a draft of all ideas that will later appear on the porcelain mugs and plates. You can still receive a binding colour proof in your hands, even without a sample. This will wing its way to you within 48 hours. A low-cost solution – simple and convenient.

NL

Benieuwd naar het eindresultaat? Met PAPERPROOF krijgt u een voorproefje van alle ideeën, die later op porseleinen mokken en bordjes gerealiseerd zullen worden. Zonder een bedrukt proefmodel ter goedkeuring vooraf krijgt u een zeer minimaal van het eindresultaat afwijkende, kleurechte afdruk op papier. Verstuurd binnen 48 uur na orderbinnenkomst. Kostenbesparend, snel en simpel.

ARZBERG



D

Arzberg: Inbegriff für hochwertiges Porzellan aus Deutschland. Diese Produkte lassen keine Wünsche offen – Langlebigkeit und Design vereint mit Ihren effektiven Werbebotschaften. Auf Wunsch lassen wir Ihnen gerne den aktuellen Arzberg-Katalog zukommen, dort können Sie sich über das erlesene Porzellansortiment informieren. Für ein individuelles Angebot stehen wir Ihnen gern zur Verfügung. Sprechen Sie uns an! Begeistern Sie Ihre Partner mit exklusivem Design, und pflegen Sie Ihre Kontakte formvollendet. Arzberg und rou bill – ein starkes Duo für starke Bindungen.

F

Arzberg est synonyme de porcelaine allemande de grande qualité. Les produits Arzberg satisferont tous vos désirs en combinant longue durée de vie, design et messages publicitaires efficaces. Si vous le souhaitez, nous pouvons vous adresser le catalogue Arzberg actuel. Vous pourrez y consulter des gammes de sélection. Nous sommes à votre disposition et pouvons établir, pour vous, une offre personnalisée. N'hésitez pas à nous contacter! Surprenez vos partenaires commerciaux avec un design exclusif. Arzberg et rou bill : un duo fort pour des relations durables.

GB

Arzberg: The epitome of high-quality porcelain from Germany. These products fulfil all your wishes – durability and design combined with your effective advertising messages. We will send you the latest Arzberg catalogue upon request so you can find out about the exquisite porcelain selection. We would be happy to provide you with an individual offer. Talk to us! Inspire your partners with an exclusive design and look after your contacts well. Arzberg and rou bill – a strong duo for strong partnerships.

NL

Arzberg: een begrip in hoogwaardig porselein uit Duitsland. Deze producten laten niets te wensen over – een lange levensduur en design in combinatie met uw wervende boodschappen. Indien gewenst sturen we u graag de actuele Arzberg catalogus toe, waarmee u kennis kunt nemen van het uitgelezen assortiment porselein. Neemt u contact met ons op voor productinformatie en een aanbieding op maat. Maak uw partners enthousiast met exclusief design, en bied ze een compleet pakket. Arzberg en rou bill – een sterk duo voor een hechte band.



MADE IN GERMANY

PORCELAIN

Optimale Individualisierbarkeit und ein funktionales Produktdesign: Die Becher und Tassen von rou bill haben das ganz besondere Etwas und verführen zu einem genussvollen Gebrauch. Jeden Tag. Zu jedem Anlass. Für jeden Geschmack.

Perfect opportunities for optimisation and a functional product design: Mugs and cups from rou bill have that special something and entice you to use them with pleasure. Every day. On every occasion. For every taste.

Personnalisation optimale et design fonctionnel: les gobelets et tasses rou bill possèdent ce petit quelque chose qui les rend simplement inimitables. Utilisation quotidienne extrêmement agréable. Pour toutes les occasions et tous les goûts.

Optimale mogelijkheden voor individualisering en functioneel productdesign: De mokken en kop en schotels van rou bill hebben iets speciaals en verleidelijks; om van te genieten. Elke dag. Bij iedere gelegenheid. Voor alle smaken.





D

APPEAL
Porzellantasse, weiß

GB

APPEAL
Porcelain mug, white

F

APPEAL
Tasse en porcelaine, blanche

NL

APPEAL
Witte porseleinen mok



0928 APPEAL

~ h 94 mm

~ Ø 100 mm

~ 0,4 l

PRINT > 80 - 81

PRINT > 82 - 83

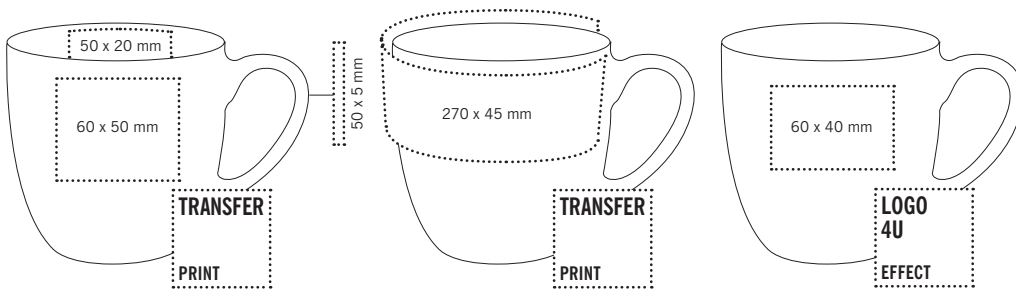

PREMIUM PHOTO PRINT	COLOUR 4U EFFECT	MAGIC IMPRESSION PRINT
------------------------	---------------------	---------------------------

PAPER PROOF SERVICE	OPTICAL BEND NECESSARY
------------------------	---------------------------

APPEAL



D
PRIME
 Porzellantasse, weiß





GB
PRIME
 Porcelain mug, white

F
PRIME
 Tasse en porcelaine, blanche

NL
PRIME
 Witte porseleinen mok



0341 PRIME

-  ~ h 105 mm
-  ~ Ø 75 mm
-  ~ 0,25 l
-  > 80 – 81
-  > 82 – 83

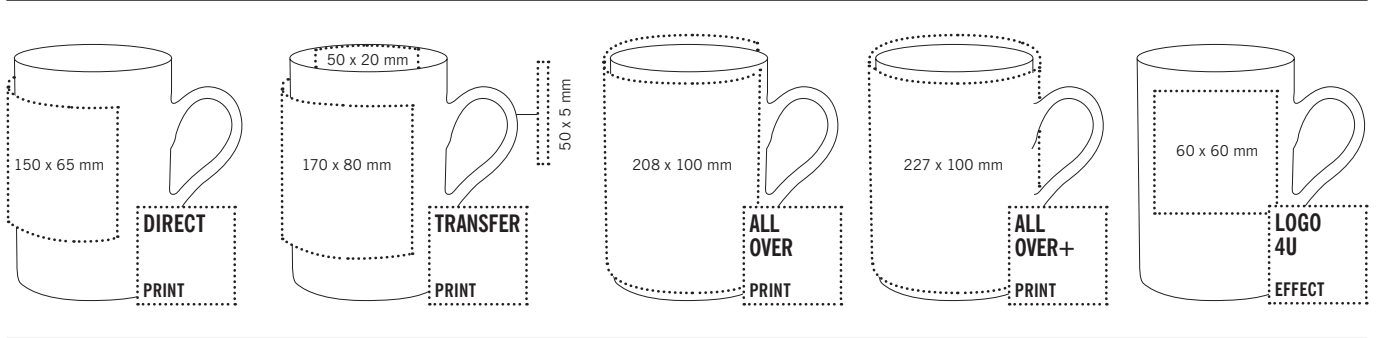

PREMIUM PHOTO PRINT	COLOUR 4U EFFECT	MAGIC IMPRESSION PRINT	PAPER PROOF SERVICE
-------------------------------	----------------------------	----------------------------------	-------------------------------

PRIME



D
PURITY
 Porzellantasse, weiß





GB
PURITY
 Porcelain mug, white

F
PURITY
 Tasse en porcelaine, blanche

NL
PURITY
 Witte porseleinen mok



0968 PURITY

-  ~ h 105 mm
-  ~ Ø 86 mm
-  ~ 0,3 l
-  > 80 – 81
-  > 82 – 83

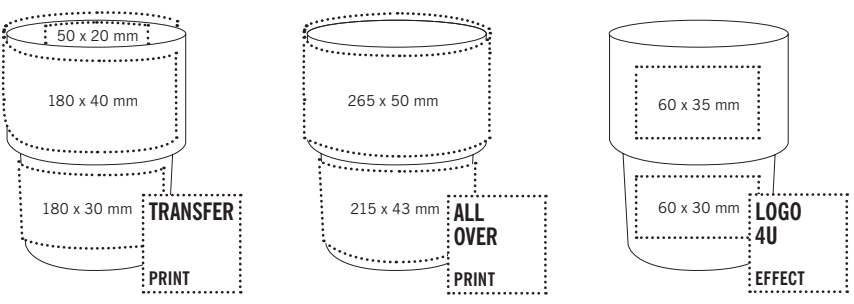

PREMIUM PHOTO PRINT	COLOUR 4U EFFECT	MAGIC IMPRESSION PRINT	PAPER PROOF SERVICE	OPTICAL BEND NECESSARY
-------------------------------	----------------------------	----------------------------------	-------------------------------	----------------------------------

PURITY



D

ELITE CHROME

Porzellantasse, hochglänzend, silber, gold, rot, blau und anthrazit

Aufgrund der Beschichtung ist das Modell 0352 nicht spülmaschinengeeignet.

GB

ELITE CHROME

Porcelain mug, high gloss, silver, gold, red, blue and dark grey

This product is not dishwasher proof.

F

ELITE CHROME

Mug en porcelaine, ultra brillant, argent, or, rouge, bleu et anthracite

En raison de la couche spéciale le modèle 0352 n'est pas lavable au lave-vaisselle.

NL

ELITE CHROME

Porseleinen mok, hoogglanzend gelakt, zilver, goud, rood, blauw of anthraciet

Vanwege de laklaag is het model 0352 niet geschikt voor de vaatwasser.



0352 ELITE CHROME

~ h 100 mm

~ Ø 81 mm

~ 0,25 l

PRINT > 80 - 81

PRINT > 82 - 83

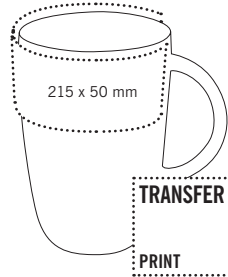
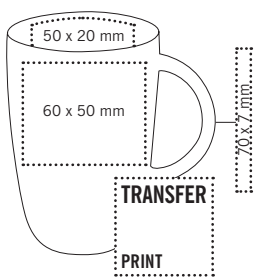

POLYLUX
PRINT

OPTICAL BEND
NECESSARY

ELITE CHROME



D
CLUB
 Porzellantasse, weiß

GB
CLUB
 Porcelain mug, white

F
CLUB
 Tasse en porcelaine, blanche

NL
CLUB
 Witte porseleinen mok





0340 CLUB

 ~ h 86 mm

 ~ Ø 82 mm

 ~ 0,25 l

 > 80 – 81

 > 82 – 83

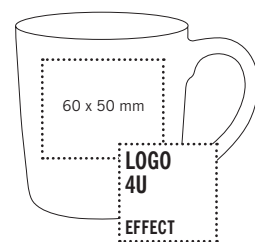
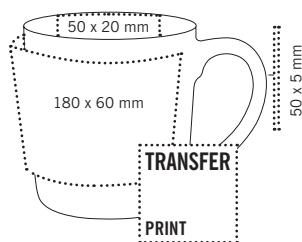
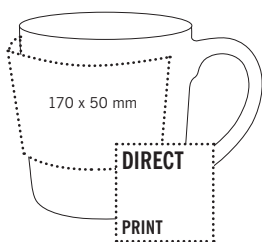

PREMIUM
PHOTO
 PRINT

COLOUR
4U
 EFFECT

MAGIC
IMPRESSION
 PRINT

PAPER
PROOF
 SERVICE

OPTICAL
BEND
 NECESSARY

CLUB



D

CLASSIC COLOUR

Porzellantasse, rot, blau, schwarz, orange, lime, mokka

Bei farbigen Drucken auf dem Modell 0974 empfehlen wir die Anfertigung eines Farbmusters!

GB

CLASSIC COLOUR

Porcelain mug, red, blue, black, orange, lime, mocha

We recommend producing a colour proof if the model 0974 is to be printed in colour!

F

CLASSIC COLOUR

Tasse en porcelaine, rouge, bleue, noire, orange, lime, mokka

Pour un marquage en couleur sur le modèle 0974, nous recommandons la fabrication d'un échantillon.

NL

CLASSIC COLOUR

Porseleinen mok, rood, blauw, zwart, oranje, lime, mokka

Voor het drukken op het model 0974 adviseren we u om vooraf een „kleurproef“ ter goedkeuring aan te vragen!





0974 CLASSIC COLOUR

 ~ h 104 mm

 ~ Ø 78 mm

 ~ 0,3 l

 > 80 – 81

 > 82 – 83

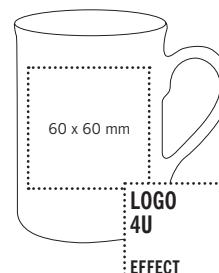
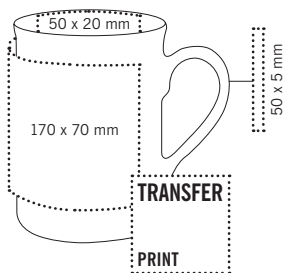

MAGIC IMPRESSION PRINT

CLASSIC COLOUR



D
DIVA
Porzellantasse, weiß

GB
DIVA
Porcelain mug, white

F
DIVA
Tasse en porcelaine, blanche

NL
DIVA
Witte porseleinen mok





0938 DIVA

 ~ h 105 mm

 ~ Ø 87 mm

 ~ 0,3 l

 > 80 – 81

 > 82 – 83

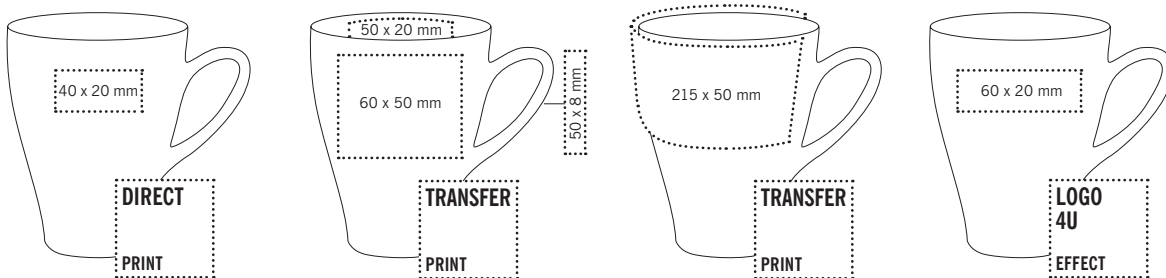

PREMIUM PHOTO
PRINT

COLOUR 4U
EFFECT

MAGIC IMPRESSION
PRINT

PAPER PROOF
SERVICE

OPTICAL BEND
NECESSARY

DIVA



D
COSMOS
 Porzellantasse, weiß

GB
COSMOS
 Porcelain mug, white

F
COSMOS
 Tasse en porcelaine, blanche

NL
COSMOS
 Witte porseleinen mok





0926 COSMOS

 ~ h 106 mm

 ~ Ø 95 mm

 ~ 0,4 l

 > 80 - 81

 > 82 - 83



PREMIUM PHOTO	COLOUR 4U	MAGIC IMPRESSION
PRINT	EFFECT	PRINT

PAPER PROOF	OPTICAL BEND
SERVICE	NECESSARY

COSMOS



D
MAXIM
 Porzellantasse, weiß

GB
MAXIM
 Porcelain mug, white

F
MAXIM
 Tasse en porcelaine, blanche

NL
MAXIM
 Witte porseleinen mok





0914 MAXIM

 ~ h 100 mm

 ~ Ø 85 mm

 ~ 0,35 l

 > 80 - 81

 > 82 - 83

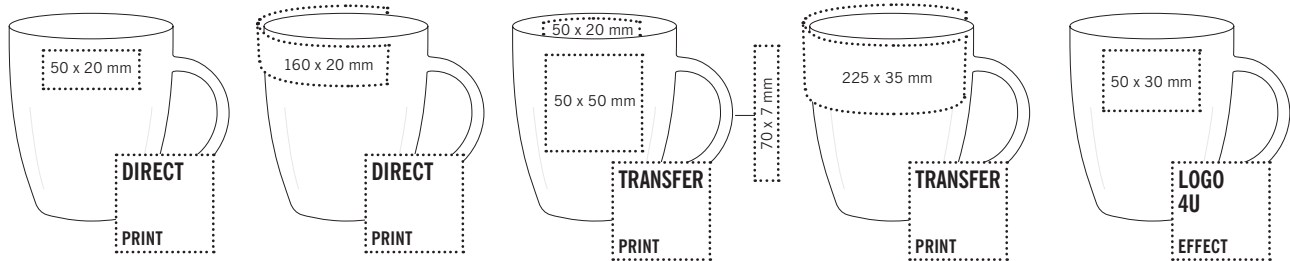

PREMIUM PHOTO
 PRINT

COLOUR 4U
 EFFECT

MAGIC IMPRESSION
 PRINT

PAPER PROOF
 SERVICE

OPTICAL BEND
 NECESSARY

MAXIM



64-69 > MAXIM BUSINESS

D

CHARISMA

Porzellantasse, weiß

GB

CHARISMA

Porcelain mug, white

F

CHARISMA

Tasse en porcelaine, blanche

NL

CHARISMA

Witte porseleinen mok





0915 CHARISMA

 ~ h 100 mm

 ~ Ø 82 mm

 ~ 0,25 l

 > 80 - 81

 > 82 - 83

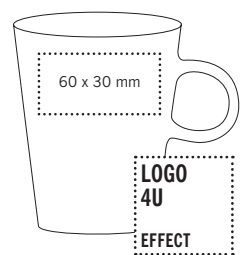
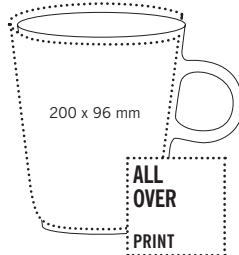
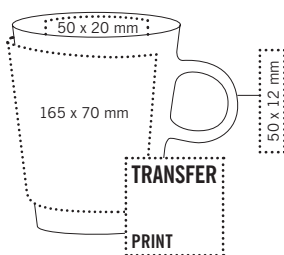
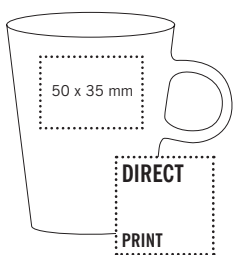

PREMIUM PHOTO
PRINT

COLOUR 4U
EFFECT

MAGIC IMPRESSION
PRINT

PAPER PROOF
SERVICE

OPTICAL BEND
NECESSARY

CHARISMA



D
ELITE
Porzellantasse, weiß

GB
ELITE
Porcelain mug, white

F
ELITE
Tasse en porcelaine, blanche

NL
ELITE
Witte porseleinen mok





0912 ELITE

 ~ h 100 mm

 ~ Ø 81 mm

 ~ 0,25 l

 > 80 - 81

 > 82 - 83

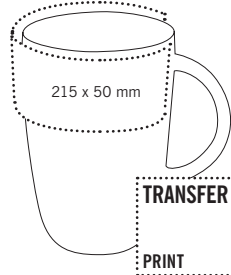
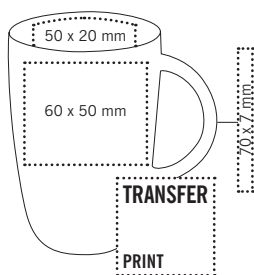
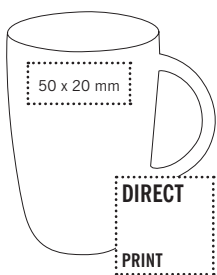

PREMIUM
PHOTO
PRINT

COLOUR
4U
EFFECT

MAGIC
IMPRESSION
PRINT

PAPER
PROOF
SERVICE

OPTICAL
BEND
NECESSARY

ELITE



D
CLASSIC
 Porzellantasse, weiß

GB
CLASSIC
 Porcelain mug, white

F
CLASSIC
 Tasse en porcelaine, blanche

NL
CLASSIC
 Witte porseleinen mok





0973 CLASSIC

 ~ h 104 mm

 ~ Ø 78 mm

 ~ 0,3 l

 > 80 – 81

 > 82 – 83

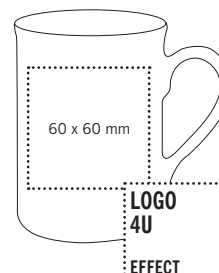
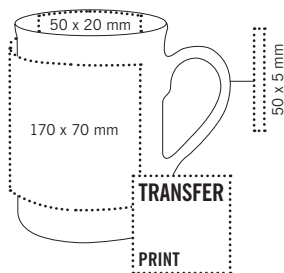
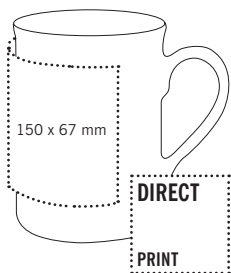

PREMIUM PHOTO
 PRINT

COLOUR 4U
 EFFECT

MAGIC IMPRESSION
 PRINT

PAPER PROOF
 SERVICE

CLASSIC



D
MAXI MUG
 Porzellantasse, weiß

GB
MAXI MUG
 Porcelain mug, white

F
MAXI MUG
 Tasse en porcelaine, blanche

NL
MAXI MUG
 Witte porseleinen mok





0344 MAXI MUG

 ~ h 93 mm

 ~ Ø 77 mm

 ~ 0,25 l

 > 80 – 81

 > 82 – 83

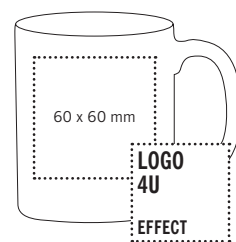
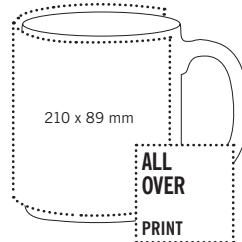
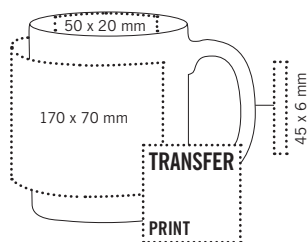
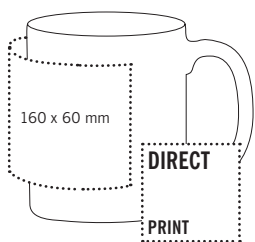

PREMIUM PHOTO
 PRINT

COLOUR 4U
 EFFECT

MAGIC IMPRESSION
 PRINT

PAPER PROOF
 SERVICE

OPTICAL BEND
 NECESSARY

for ALL-OVER PRINT only

MAXI MUG



D

SPECIAL

Porzellantasse, weiß

CULT

Porzellantasse, weiß

GB

SPECIAL

Porcelain mug, white

CULT

Porcelain mug, white

F

SPECIAL

Tasse en porcelaine, blanche

CULT

Tasse en porcelaine, blanche

NL

SPECIAL

Witte porseleinen mok

CULT

Witte porseleinen mok





0305 SPECIAL

 ~ h 95 mm

 ~ Ø 80 mm

 ~ 0,25 l

 > 80 - 81

 > 82 - 83

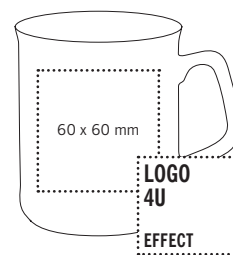
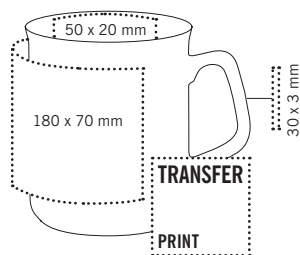
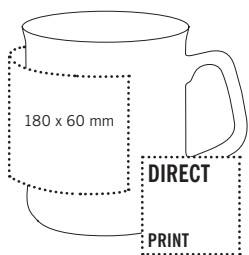

PREMIUM PHOTO
PRINT

COLOUR 4U
EFFECT

MAGIC IMPRESSION
PRINT

PAPER PROOF
SERVICE

SPECIAL CULT



0911 CULT

 ~ h 105 mm

 ~ Ø 75 mm

 ~ 0,25 l

 ~ > 82 - 85

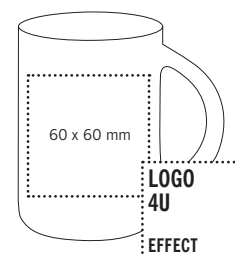
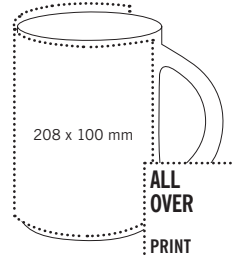
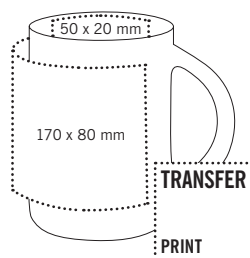
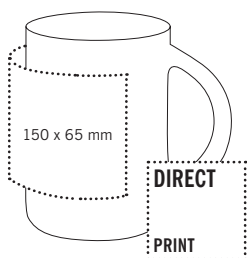

PREMIUM PHOTO
PRINT

COLOUR 4U
EFFECT

MAGIC IMPRESSION
PRINT

PAPER PROOF
SERVICE

OPTICAL BEND
NECESSARY

for ALL-OVER PRINT only

GLASS

Vom klassischen Trinkglas bis zum Henkelbecher aus satiniertem Glas – die formschönen Trinkgefäße passen in jedes Ambiente. Mit einer persönlichen Werbebotschaft veredelt, sind sie ein glasklarer Blickfang!

From a traditional drinking glass to a mug with a handle made of frosted glass – the beautifully formed drinking vessels suit every occasion. Finished with a personal advertising message, they are a clear eye-catcher!

Du verre classique au gobelet à anse en verre satiné: ces articles aux jolies formes s'adaptent à toutes les ambiances. Dotés d'un message publicitaire personnalisé, ils constituent une accroche « claire comme du cristal »!

Van klassieke drinkglazen tot gesatineerd glazen mokken – ons welgevormde assortiment glazen past bij iedere sfeer. Veredeld met een persoonlijke reclameboodschap vormt het een glasheldere blikvanger!





D

DIAMOND MUG

Henkelbecher, farbiges Glas

Bei farbigen Drucken auf dem Modell 0960 empfehlen wir die Anfertigung eines Farbmusters!

GB

DIAMOND MUG

Coloured glass mug with handle

We recommend producing a colour proof if the model 0960 is to be printed in colour!

F

DIAMOND MUG

Mug, verre coloré

Pour un marquage en couleur sur le modèle 0960, nous recommandons la fabrication d'un échantillon.

NL

DIAMOND MUG

Mok van gekleurd glas

Voor het drukken op het model 0960 adviseren we u om vooraf een „kleurproof“ ter goedkeuring aan te vragen!



0960 DIAMOND MUG

~ h 97 mm

~ Ø 80 mm

~ 0,25 l

PRINT > 80 – 81

PRINT > 82 – 83

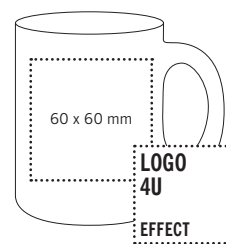
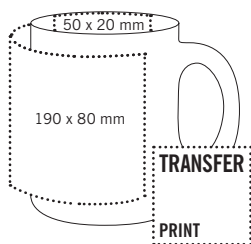
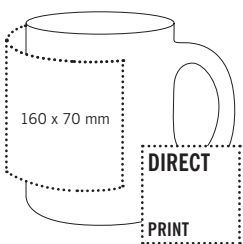

DIAMOND MUG



D

FROZEN MUG

Henkelbecher, satiniertes Glas

FROZEN COLOUR

Henkelbecher, satiniertes Glas, schwarz, grün, blau

Bei farbigen Drucken auf dem Modell 0972 empfehlen wir die Anfertigung eines Farbmusters!

GB

FROZEN MUG

Mug with handle, with frosted glass surface

FROZEN COLOUR

Black, green and blue glass mug with frosted glass surface

We recommend producing a colour proof if the model 0972 is to be printed in colour!

F

FROZEN MUG

Mug, verre satiné

FROZEN COLOUR

Mug, verre satiné, noir, vert, bleu

Pour un marquage en couleur sur le modèle 0972, nous recommandons la fabrication d'un échantillon.

NL

FROZEN MUG

Frosted mok van gesatineerd glas

FROZEN COLOUR

Frosted mok van gesatineerd glas, zwart, groen, blauw

Voor het drukken op het model 0972 adviseren we u om vooraf een „kleurproef“ ter goedkeuring aan te vragen!

0970 FROZEN MUG

~ h 97 mm

~ Ø 80 mm

~ 0,25 l

PRINT > 80 – 81

> 82 – 83

0972 FROZEN COLOUR

~ h 97 mm

~ Ø 80 mm

~ 0,25 l

PRINT > 80 – 81

> 82 – 83

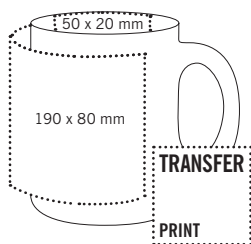
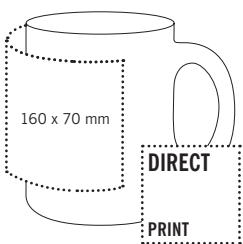

GLOSSY IMPRESSION
PRINT

FROZEN MUG

FROZEN COLOUR



D

FROZEN STAR

Henkelbecher, satiniertes Glas

CLEAR STAR

Henkelbecher, Klarglas

GB

FROZEN STAR

Frosted glass mug with handle

CLEAR STAR

Mug with handle, clear glass

F

FROZEN STAR

Mug, verre satiné

CLEAR STAR

Mug, verre transparent

NL

FROZEN STAR

Frosted mok van gesatineerd glas

CLEAR STAR

Mok van helder glas

0975 FROZEN STAR

0975

 ~ h 130 mm

 ~ Ø 80 mm

 ~ 0,35 l

 > 80 - 81

 > 82 - 83

0976 CLEAR STAR

 ~ h 130 mm

 ~ Ø 80 mm

 ~ 0,35 l

 > 80 - 81

 > 82 - 83

0988

Untertasse
Saucer
Soucoupe
Schotel

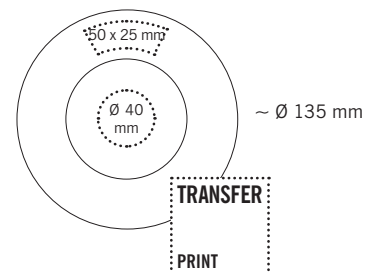
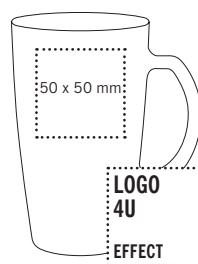
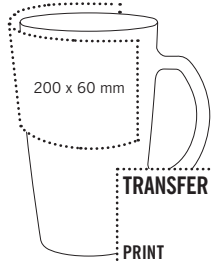
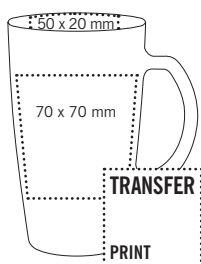
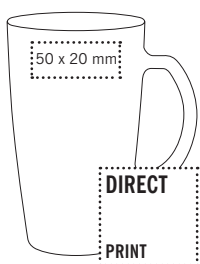

GLOSSY IMPRESSION
PRINT
for 0975 only

LOGO 4U
EFFECT
for 0976 only

OPTICAL BEND
NECESSARY

FROZEN STAR

CLEAR STAR



0976



0976

0988

D

FROZEN JUICE

Trinkglas, satiniert

FROZEN CUP

Henkelbecher, satiniertes Glas

GB

FROZEN JUICE

Drinking glass, with frozen surface

FROZEN CUP

Frosted glass mug with handle

F

FROZEN JUICE

Verre, satiné

FROZEN CUP

Mug, verre satiné

NL

FROZEN JUICE

Drinkglas van gesatineerd glas

FROZEN CUP

Frosted mok van gesatineerd glas



0980 FROZEN JUICE

~ h 110 mm

~ Ø 64 mm

~ 0,25 l

PRINT > 80 – 81

PRINT > 82 – 83

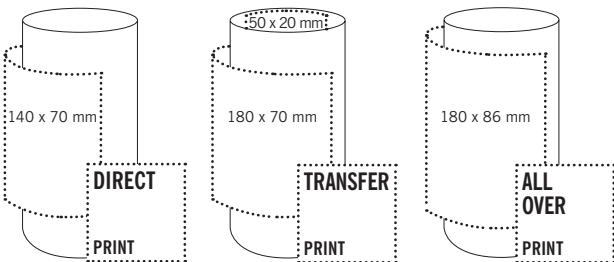

GLOSSY IMPRESSION
PRINT

FROZEN JUICE

FROZEN CUP





0978 FROZEN CUP

 ~ h 105 mm

 ~ Ø 100 mm

 ~ 0,4 l

 > 80 - 81

 > 82 - 83

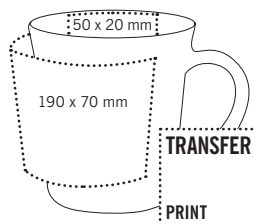
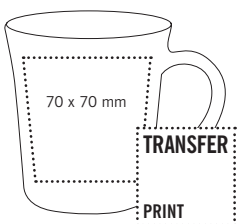

**GLOSSY
IMPRESSION**
PRINT

**OPTICAL
BEND**
NECESSARY

D

CLEAR AQUA
Trinkglas, klar

CLEAR AQUA MINI
Trinkglas, klar

GB

CLEAR AQUA
Drinking glass, clear

CLEAR AQUA MINI
Drinking glass, clear

F

CLEAR AQUA
Verre, transparent

CLEAR AQUA MINI
Verre, transparent

NL

CLEAR AQUA
Drinkglas, transparant

CLEAR AQUA MINI
Drinkglas, transparant





0986 CLEAR AQUA

 ~ h 149 mm

 ~ Ø 88 mm

 ~ 0,4 l

 > 80 – 81

 > 82 – 83

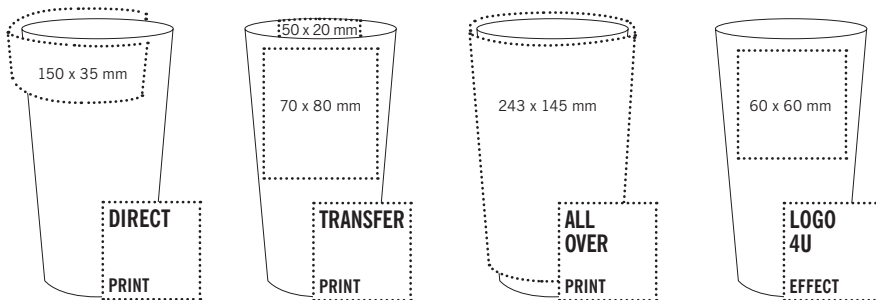

**OPTICAL
BEND
NECESSARY**

CLEAR AQUA

CLEAR AQUA MINI





0982 CLEAR AQUA MINI

 ~ h 130 mm

 ~ Ø 75 mm

 ~ 0,25 l

 **PRINT** > 80 – 81

 > 82 – 83

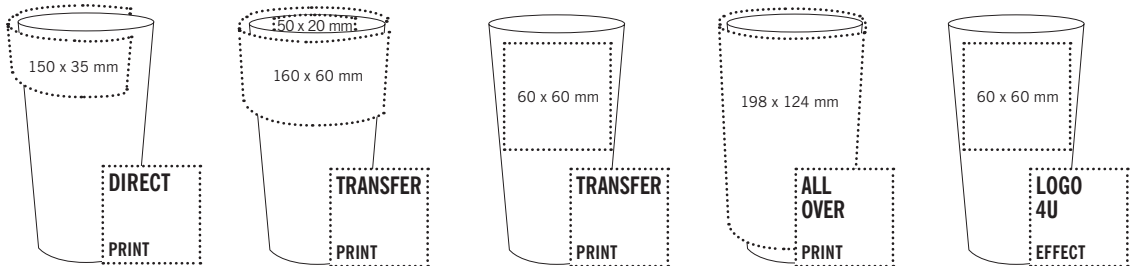

OPTICAL BEND NECESSARY

STEEL

Coole Optik für unterwegs: Die modernen Thermobecher aus doppelwandigem Edelstahl halten Ihr Getränk genau auf Temperatur und sind ideal für Kaffee, Tee, Glühwein oder Eistee.

Cool looks for out and about: The modern thermos mugs made of double-walled stainless steel keep your drink at exactly the right temperature and are ideal for coffee, tea, mulled wine or iced tea.

Aspect sympa pour une utilisation itinérante: les gobelets thermos modernes présentant une double paroi en acier maintiennent vos boissons à température et conviennent parfaitement au transport de café, de thé, de vin chaud ou encore de thé glacé.

De coole look voor onderweg: deze moderne thermobekers van dubbelwandig edelstaal houden uw drinken perfect op temperatuur en zijn ideaal voor koffie, thee of icetea.





D

TROPHY

Vakuum-Thermobecher,
doppelwandiger 18/8 Edelstahl

TITAN

Thermobecher,
doppelwandiger 18/8 Edelstahl

GB

TROPHY

Vacuum thermo mug,
double-walled 18/8 stainless steel

TITAN

Thermo mug,
double-walled 18/8 stainless steel

F

TROPHY

Gobelets thermos avec vacuum, à
double paroi. Acier inoxydable 18/8

TITAN

Gobelets thermos, à double paroi.
Acier inoxydable 18/8

NL

TROPHY

Vacuüm-thermobeker,
dubbelwandig 18/8 edelstaal

TITAN

Thermobeker,
dubbelwandig 18/8 edelstaal



0750 TROPHY

~ h 170 mm

~ Ø 82 mm

~ 0,35 l

PRINT > 80 – 81

> 82 – 83

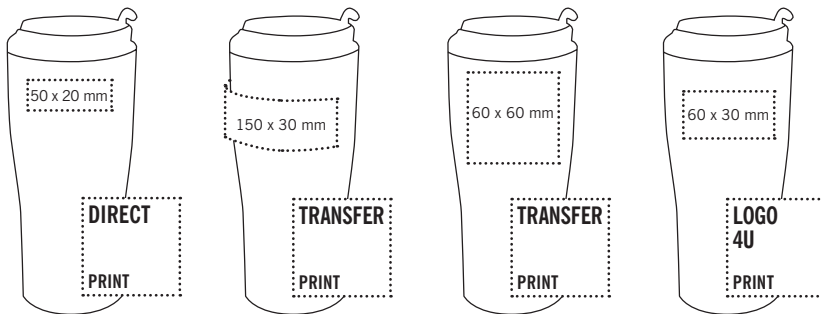

POLYLUX
PRINT

OPTICAL BEND
NECESSARY

TROPHY

TITAN





0751 TITAN

 ~ h 137 mm

 ~ Ø 90 mm

 ~ 0,3 l

 > 80 - 81

 > 82 - 83

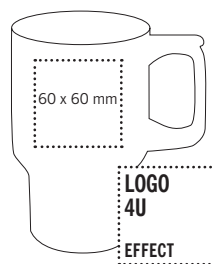
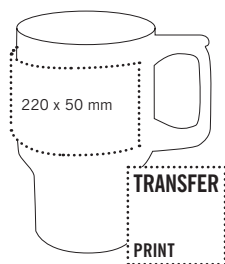
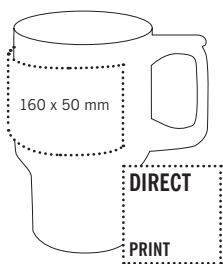

 POLYLUX

 PRINT

D

SWING S

Espresso-Löffel, 18/0 Edelstahl

SWING M

Kaffee-Löffel, 18/0 Edelstahl

SWING L

Latte Macchiato-Löffel,
18/0 Edelstahl

GB

SWING S

Espresso spoon, 18/0 stainless steel

SWING M

Coffee spoon, 18/0 stainless steel

SWING L

Latte Macchiato spoon,
18/0 stainless steel

F

SWING S

Cuillères à espresso, 18/0 inox

SWING M

Cuillères à café, 18/0 inox

SWING L

Cuillères à latte macchiato,
18/0 inox

NL

SWING S

Espresso-lepel, 18/0 edelstaal

SWING M

Koffie-lepel, 18/0 edelstaal

SWING L

Latte Macchiato-lepel,
18/0 edelstaal

0960 SWING S



~ | 115 mm



0961 SWING M

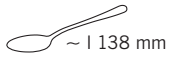

~ | 138 mm



0962 SWING L



~ | 198 mm

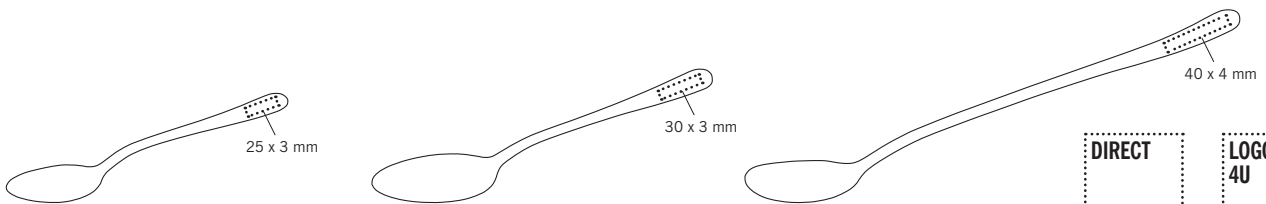

DIRECT
PRINT

LOGO
4U
PRINT

SWING



BUSINESS SETS

Es ist der erste Eindruck, der zählt. Die formvollendeten Business Sets im exquisiten Design verleihen jedem Tisch einen besonderen Akzent – ganz gleich, ob im alltäglichen Büroleben oder bei einem wichtigen Kundenmeeting.

The first impression counts. The corporate giftsets, perfect in form and with an exquisite design, give every table a special note – regardless of whether in daily office life or at an important customer meeting.

C'est la première impression qui compte ! Les sets Business aux formes parfaites et au design de première classe confèrent un caractère particulier aux tables, autant dans l'enceinte de bureaux que dans le cadre d'un meeting important avec des clients.

De eerste impressie telt. De volmaakt gevormde business sets in exclusief design geven aan elke tafel een bijzonder accent – of het nu tijdens het dagelijkse kantoorleven is of bij een belangrijke afspraak met een klant.



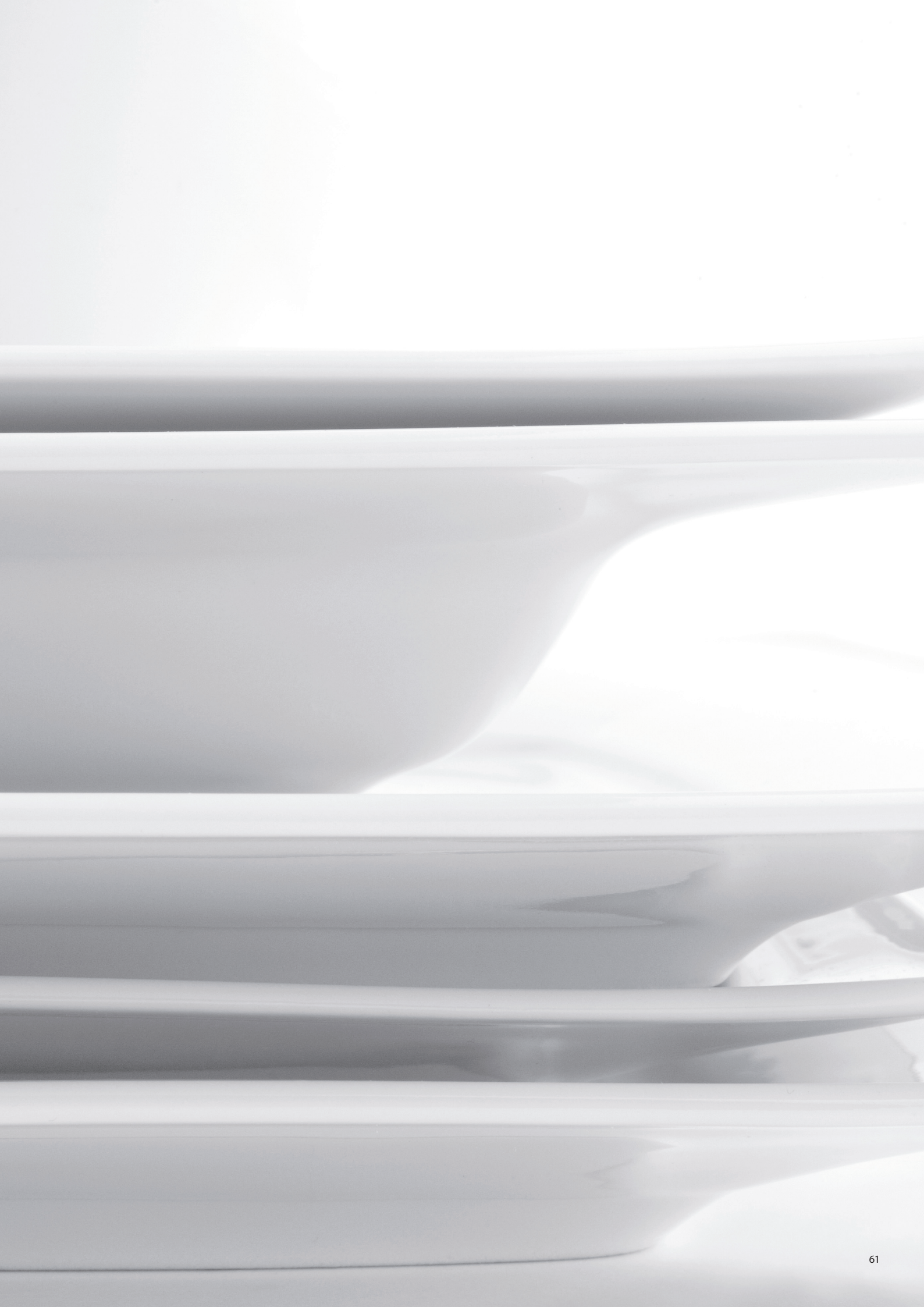

D

CARA MIA ESPRESSO

Porzellantasse mit Untertasse, weiß

GB

CARA MIA ESPRESSO

Porcelain mug and saucer, white

F

CARA MIA ESPRESSO

Tasse et soucoupe en porcelaine, blanches

NL

CARA MIA ESPRESSO

Kop en schotel van wit porselein

0931 CARA MIA ESPRESSO SET

-  ~ h 50 mm
-  ~ Ø 62 mm
-  ~ 0,06 l
-  ~ Ø 125 mm
-  > 80 - 81
-  > 82 - 83



0932 CARA MIA ESPRESSO DUO

-  x 2
-  x 2
-  > inclusive

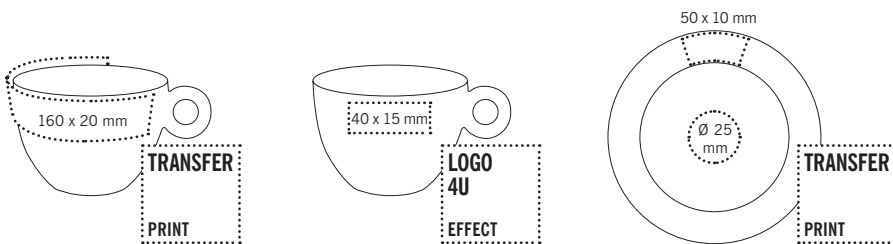

**PREMIUM
PHOTO
PRINT**

**PAPER
PROOF
SERVICE** **OPTICAL
BEND
NECESSARY**

CARA MIA ESPRESSO



for 0932 only

D

CARA MIA CAPPUCCINO
Porzellantasse mit Untertasse, weiß
CARA MIA CAFFÈ LATTE
Porzellantasse mit Untertasse, weiß

GB

CARA MIA CAPPUCCINO
Porcelain mug and saucer, white
CARA MIA CAFFÈ LATTE
Porcelain mug and saucer, white

F



CARA MIA CAPPUCCINO
Tasse et soucoupe en porcelaine,
blanches
CARA MIA CAFFÈ LATTE
Tasse et soucoupe en porcelaine,
blanches

NL

CARA MIA CAPPUCCINO
Kop en schotel van wit porselein
CARA MIA CAFFÈ LATTE
Kop en schotel van wit porselein



**0933 CARA MIA
CAPPUCCINO SET**

-  ~ h 64 mm
-  ~ Ø 90 mm
-  ~ 0,2 l
-  ~ Ø 145 mm
-  > 80 – 81
-  > 82 – 83

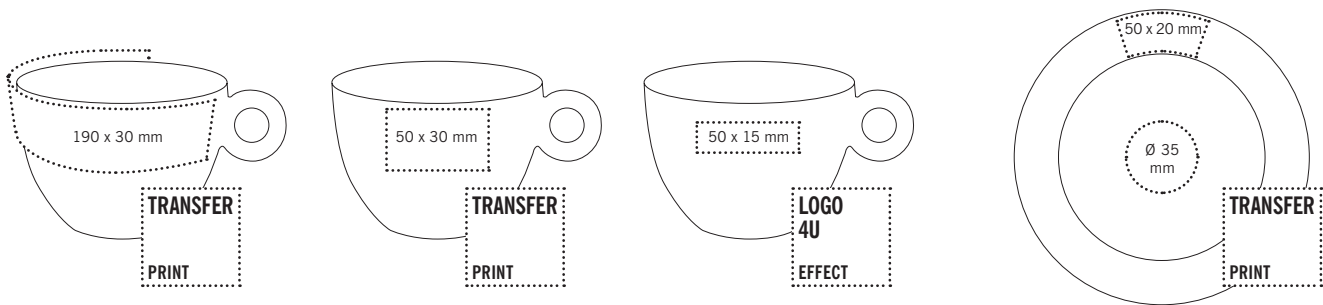

**PREMIUM
PHOTO
PRINT**

**PAPER
PROOF
SERVICE** **OPTICAL
BEND
NECESSARY**

CARA MIA CAPPUCCINO

CARA MIA CAFFÈ LATTE



0934 CARA MIA CAFFÈ LATTE SET

-  ~ h 70 mm
-  ~ Ø 105 mm
-  ~ 0,28 l
-  ~ Ø 165 mm
-  > 80 - 81
-  > 82 - 83

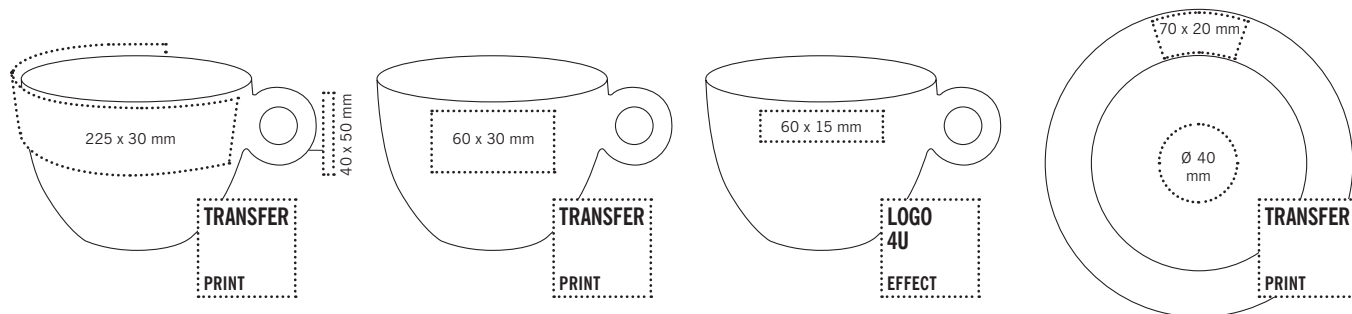

**PREMIUM
PHOTO
PRINT**

**PAPER
PROOF
SERVICE** **OPTICAL
BEND
NECESSARY**

D

MAXIM ESPRESSO

Porzellantasse mit Untertasse, weiß

GB

MAXIM ESPRESSO

Porcelain mug and saucer, white

F

MAXIM ESPRESSO

Tasse et soucoupe en porcelaine, blanches

NL

MAXIM ESPRESSO

Kop en schotel van wit porselein

0977 MAXIM ESPRESSO SET

 ~ h 60 mm

 ~ Ø 60 mm

 ~ 0,09 l

 ~ Ø 115 mm

 > 80 - 81

 > 82 - 83



0987 MAXIM ESPRESSO DUO

 x 2

 x 2

 > inclusive

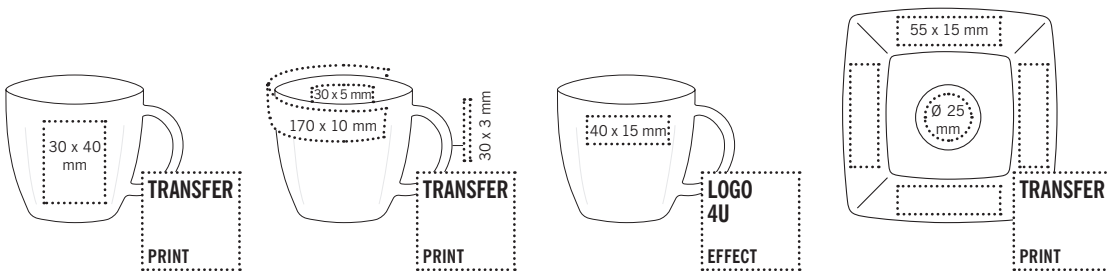

PREMIUM PHOTO
PRINT

MAGIC IMPRESSION
PRINT

PAPER PROOF
SERVICE

OPTICAL BEND
NECESSARY

MAXIM ESPRESSO



0987



for 0987 only

D

MAXIM CAFÉ

Porzellantasse, weiß

MAXIM CAFÉ SET

Porzellantasse mit Untertasse, weiß

GB

MAXIM CAFÉ

Porcelain mug, white

MAXIM CAFÉ SET

Porcelain mug and saucer, white

F

MAXIM CAFÉ

Tasse en porcelaine, blanche

MAXIM CAFÉ SET

Tasse et soucoupe en porcelaine, blanches

NL

MAXIM CAFÉ

Witte porseleinen mok

MAXIM CAFÉ SET

Kop en schotel van wit porselein

0907 MAXIM CAFÉ

 ~ h 81 mm

 ~ Ø 79 mm

 ~ 0,2 l

 > 80 - 81

 > 82 - 83

0937 MAXIM CAFÉ SET

 ~ h 81 mm

 ~ Ø 79 mm

 ~ 0,2 l

 ~ Ø 150 mm

 > 80 - 81

 > 82 - 83

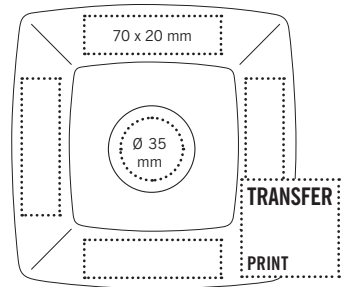
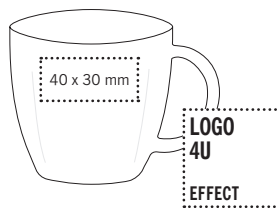
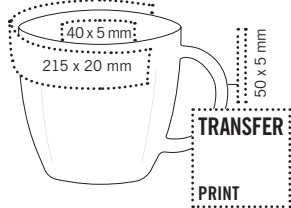
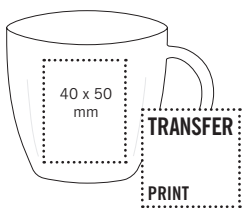

PREMIUM PHOTO
PRINT

COLOUR 4U
EFFECT

for 0907 only

PAPER PROOF
SERVICE

OPTICAL BEND
NECESSARY

MAXIM CAFÉ



D

MAXIM START-UP-BOX
74 Einzelteile, Porzellan, weiß

MAXIM PLATE
Porzellanteller, weiß
Weitere Artikel auf Anfrage erhältlich.

GB

MAXIM START-UP-BOX
74 piece, porcelain, white

MAXIM PLATE
Porcelain plate, white
Other articles available upon request.

F

MAXIM START-UP-BOX
74 pièces, porcelaine blanches

MAXIM PLATE
Assiette en porcelaine, blanche
D'autres articles sont disponibles à la demande.

NL

MAXIM START-UP-BOX
74-delig, witte porseleinen set

MAXIM PLATE
Porseleinen bord, wit
Aanvullende artikelen op aanvraag verkrijgbaar.

0927 MAXIM PLATE

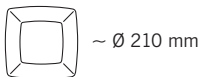

0952 MAXIM START-UP-BOX

-  x 24
-  x 24
-  x 1
-  x 1

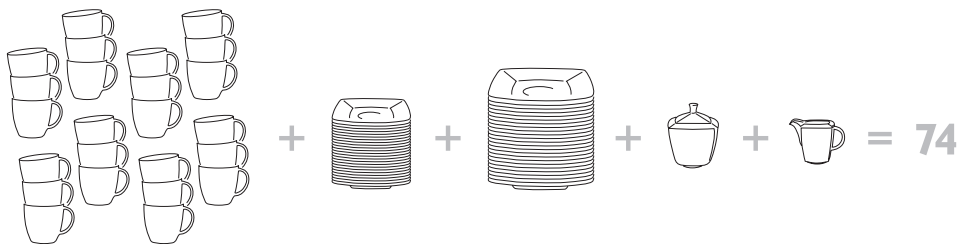

40 x 20 mm

PREMIUM PHOTO PRINT
MAGIC IMPRESSION PRINT

PAPER PROOF SERVICE
OPTICAL BEND NECESSARY

MAXIM START-UP-BOX

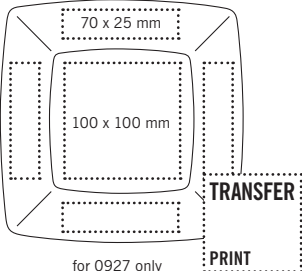

D

FANCY ESPRESSO

Porzellantasse mit Untertasse, weiß

GB

FANCY ESPRESSO

Porcelain mug and saucer, white

F

FANCY ESPRESSO

Tasse et soucoupe en porcelaine, blanches

NL

FANCY ESPRESSO

Kop en schotel van wit porselein

0964 FANCY ESPRESSO SET

 ~ h 57 mm

 ~ Ø 67 mm

 ~ 0,13 l

 ~ Ø 120 mm

 > 80 - 81

 > 82 - 83



0984 FANCY ESPRESSO DUO

 x 2

 x 2

 > inclusive

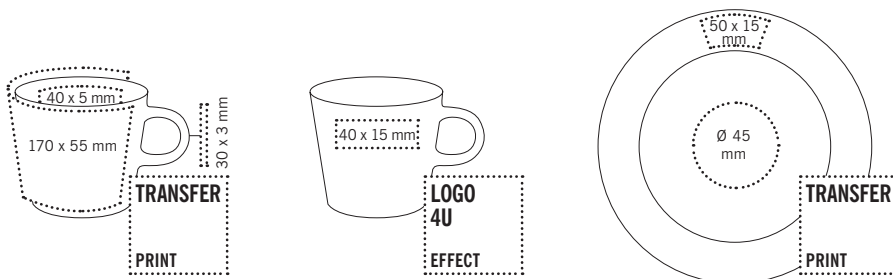

PREMIUM PHOTO
PRINT

MAGIC IMPRESSION
PRINT

PAPER PROOF
SERVICE

OPTICAL BEND
NECESSARY

FANCY ESPRESSO



0984



for 0984 only

D

FANCY CAFÉ

Porzellantasse mit Untertasse, weiß

GB

FANCY CAFÉ

Porcelain mug and saucer, white

F

FANCY CAFÉ

Tasse et soucoupe en porcelaine, blanches

NL

FANCY CAFÉ

Kop en schotel van wit porselein



0965 FANCY CAFÉ SET

-  ~ h 70 mm
-  ~ Ø 82 mm
-  ~ 0,2 l
-  ~ Ø 144 mm
-  > 80 – 81
-  > 82 – 83

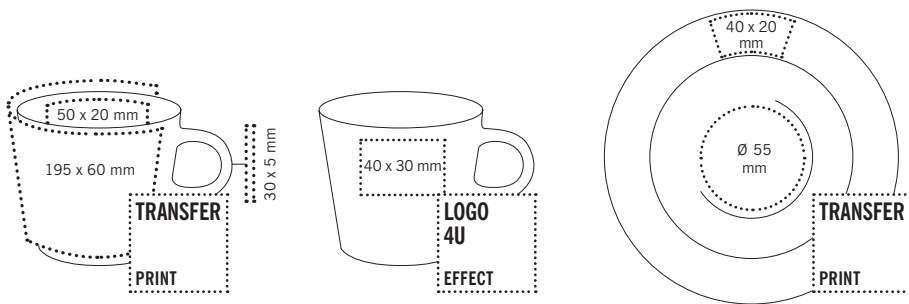

PREMIUM PHOTO PRINT
MAGIC IMPRESSION PRINT

PAPER PROOF SERVICE
OPTICAL BEND NECESSARY

FANCY CAFÉ SET



D

FANCY START-UP-BOX

74 Einzelteile, Porzellan, weiß

FANCY PLATE

Porzellanteller, weiß

Weitere Artikel auf Anfrage erhältlich.

GB

FANCY START-UP-BOX

74 piece, porcelain, white

FANCY PLATE

Porcelain plate, white

Other articles available upon request.

F

FANCY START-UP-BOX

74 pièces, porcelaine blanches

FANCY PLATE

Assiette en porcelaine, blanche

D'autres articles sont disponibles à la demande.

NL

FANCY START-UP-BOX

74-delig, witte porseleinen set

FANCY PLATE



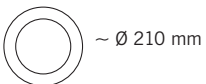

Porseleinen bord, wit

Aanvullende artikelen op aanvraag verkrijgbaar.

0966 FANCY PLATE



0951 FANCY START-UP-BOX

-  x 24
-  x 24
-  x 1
-  x 1

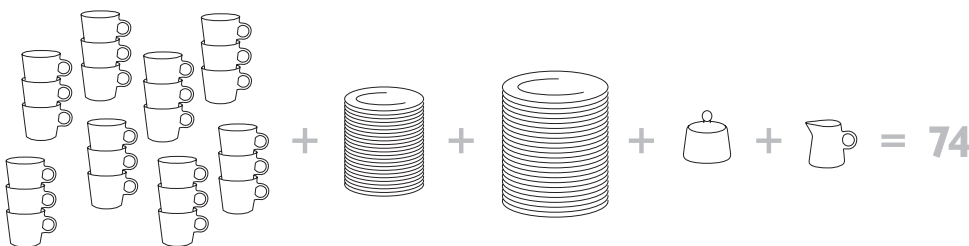

PREMIUM PHOTO PRINT

MAGIC IMPRESSION PRINT

PAPER PROOF SERVICE

OPTICAL BEND NECESSARY

FANCY START-UP-BOX

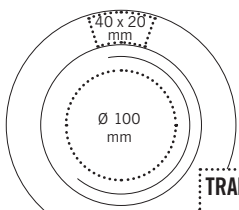

TRANSFER

PRINT

for 0966 only

STANDARDMOTIVE · STANDARD DESIGNS

D

Die Gestaltung Ihrer Tassen ist Ihnen zu zeitaufwändig? Kein Problem, mit unseren Standardmotiven ist für jeden Geschmack etwas dabei. Sie haben die Möglichkeit, die Tassen mit dem gewünschten Standardmotiv, oder zusätzlich mit Ihrem Logo, zu bestellen. Natürlich schon ab einer geringen Auflage von 108 Stück.

GB

If time is of the essence, why not take advantage of our range of standard designs. With something to suit every taste, you also have the option of adding your logo to the standard design. Minimum order quantities are 108 mugs.

F

Personnaliser vos tasses requiert trop de temps? Nous avons la solution : avec l'éventail de nos motifs standards, il y en a pour tous les goûts. Vous pouvez commander vos tasses avec le motif standard souhaité ou avec votre logo, ce à partir de 108 unités.

NL

De tijd om een fraai motief op uw mokken samen te stellen ontbreekt u? Geen probleem, met onze standaardmotieven is er voor elk wat wils. We bieden u de mogelijkheid de mokken alleen met het door u gewenste standaardmotief, of in combinatie met uw logo te bestellen. Natuurlijk al vanaf slechts 108 stuks.



0914 MAXIM
„Kaffee“

Zusätzliche Druckflächen

Innendruck: 50 x 20 mm
Henkeldruck: 70 x 7 mm

0914 MAXIM
„Coffee“

Additional print areas

Inside printing: 50 x 20 mm
Handle printing: 70 x 7 mm

0914 MAXIM
„Café“

Autres surfaces d'impression

Impression intérieure:
50 x 20 mm
Impression sur la anse:
70 x 7 mm

0914 MAXIM
„Koffie“

Extra drukoppervlakken

Bedrukking aan de binnenzijde: 50 x 20 mm
Bedrukking op het oor: 70 x 7 mm



0914 MAXIM
„Früher Vogel“

Zusätzliche Druckflächen

Innendruck: 50 x 20 mm
Henkeldruck: 70 x 7 mm

0914 MAXIM
„Früher Vogel“

Additional print areas

Inside printing: 50 x 20 mm
Handle printing: 70 x 7 mm

0914 MAXIM
„Früher Vogel“

Autres surfaces d'impression

Impression intérieure:
50 x 20 mm
Impression sur la anse:
70 x 7 mm

0914 MAXIM
„Früher Vogel“

Extra drukoppervlakken

Bedrukking aan de binnenzijde: 50 x 20 mm
Bedrukking op het oor: 70 x 7 mm



0968 PURITY
„Täglich Kaffee“

Zusätzliche Druckflächen

Innendruck: 50 x 20 mm
Außendruck unten:
180 x 30 mm

0968 PURITY
„Täglich Kaffee“

Additional print areas

Inside printing: 50 x 20 mm
Outside printing:
180 x 30 mm

0968 PURITY
„Täglich Kaffee“

Autres surfaces d'impression

Impression intérieure:
50 x 20 mm
Impression en bas:
180 x 30 mm

0968 PURITY
„Täglich Kaffee“

Extra drukoppervlakken

Bedrukking aan de binnenzijde: 50 x 20 mm
Drukformaat:
180 x 30 mm

MOTIFS STANDARD · STANDAARDMOTIEVEN



0341 PRIME
„Labyrinth“

Zusätzliche Druckflächen
Innendruck: 50 x 20 mm
Henkeldruck: 50 x 5 mm

0341 PRIME
„Labyrinth“

Additional print areas
Inside printing: 50 x 20 mm
Handle printing: 50 x 5 mm

0341 PRIME
„Labyrinth“

Autres surfaces d'impression
Impression intérieure: 50 x 20 mm
Impression sur la anse: 50 x 5 mm

0341 PRIME
„Labyrinth“

Extra drukoppervlakken
Bedrukking aan de binnenzijde: 50 x 20 mm
Bedrukking op het oor: 50 x 5 mm



0926 COSMOS
„Morgenmuffel“

Zusätzliche Druckflächen
Innendruck: 50 x 20 mm
Henkeldruck: 60 x 8 mm

0926 COSMOS
„Morgenmuffel“

Additional print areas
Inside printing: 50 x 20 mm
Handle printing: 60 x 8 mm

0926 COSMOS
„Morgenmuffel“

Autres surfaces d'impression
Impression intérieure: 50 x 20 mm
Impression sur la anse: 60 x 8 mm

0926 COSMOS
„Morgenmuffel“

Extra drukoppervlakken
Bedrukking aan de binnenzijde: 50 x 20 mm
Bedrukking op het oor: 60 x 8 mm



0911 CULT
„Black tapes“

Zusätzliche Druckflächen
Innendruck: 50 x 20 mm

0911 CULT
„Black tapes“

Additional print areas
Inside printing: 50 x 20 mm

0911 CULT
„Black tapes“

Autres surfaces d'impression
Impression intérieure: 50 x 20 mm

0911 CULT
„Black tapes“

Extra drukoppervlakken
Bedrukking aan de binnenzijde: 50 x 20 mm



0974 CLASSIC COLOUR
„White curl“

Zusätzliche Druckflächen
Innendruck: 50 x 20 mm
Henkeldruck: 50 x 5 mm

0974 CLASSIC COLOUR
„White curl“

Additional print areas
Inside printing: 50 x 20 mm
Handle printing: 50 x 5 mm

0974 CLASSIC COLOUR
„White curl“

Autres surfaces d'impression
Impression intérieure: 50 x 20 mm
Impression sur la anse: 50 x 5 mm

0974 CLASSIC COLOUR
„White curl“

Extra drukoppervlakken
Bedrukking aan de binnenzijde: 50 x 20 mm
Bedrukking op het oor: 50 x 5 mm

DRUCK · PRINT · IMPRESSION · DRUKTECHNIEK

LOGO 4U
EFFECT



D

Mit LOGO 4U wird Ihre Botschaft direkt in die Mug-Oberfläche gestrahlt: für spürbare Eleganz.

- Volle Wirkung dank edler Haptik
- Perfekt in Verbindung mit COLOUR 4U
- Verleiht Tiefe und Struktur

GB

LOGO 4U allows you to reproduce your message directly on to the surface of the mug, for impactful results.

- striking tactile results
- perfect in combination with COLOUR 4U
- Provides depth and structure

F

Grâce à LOGO 4U, votre message est imprimé directement sur la surface de la tasse à anse: une élégance délectable.

- plein effet garanti grâce à une haptique noble
- combinaison parfaite avec COLOUR 4U
- confère de la profondeur et de la structure

NL

Logo's en reclameboodschappen worden met LOGO 4U direct in de mok gezandstraald: voor voelbare elegantie.

- Schitterend effect dankzij hoogwaardige techniek
- Zeer fraai te combineren met COLOUR 4U
- Geeft diepte en structuur

MAGIC IMPRESSION
PRINT



MAGIC IMPRESSION-Farbe kann Motive verdecken, um sie beim Befüllen mit heißer Flüssigkeit erscheinen zu lassen.

- Zauberhafter Effekt
- Vorher-Nachher-Zustände
- Handspülung

MAGIC IMPRESSION colour can conceal a motif and let it reappear when the mug is filled with a hot liquid.

- magical effect
- before-after situation
- hand washing

La couleur MAGIC IMPRESSION masque les motifs et les laisse réapparaître lors du remplissage avec une boisson chaude.

- effet magique
- états avant et après
- lavage manuel

De MAGIC IMPRESSION-inkt kan motieven verbergen om ze weer te laten verschijnen, zodra de mok gevuld wordt met een warme vloeistof.

- Magisch resultaat
- Voor en na simulatie
- Handmatig afwassen

COLOUR 4U
EFFECT



Wählen Sie COLOUR 4U, und wir färben die Außenseite der Tasse komplett in individueller Farbe ein.

- Ideale Individualisierbarkeit
- Einfärbung nach Wunsch
- Schon ab 108 Stück

Choose COLOUR 4U, and we will customise the outside of your mug with your individual colour.

- full individualization
- every mug in your CI-colour
- min. order qty. only 108 pcs.

Choisissez COLOUR 4U et nous teindrons la face extérieure de la tasse selon la couleur de votre choix.

- individualisation idéale
- coloriage selon désir
- déjà à partir de 108 pièces

Kies voor COLOUR 4U, en wij spuiten de buitenkant van de mok in de door u gewenste kleur.

- Uitstekend te personaliseren
- Mokken in huisstijlkleuren
- Al vanaf 108 stuks

PREMIUM PHOTO
PRINT



Im PREMIUM PHOTO PRINT-Verfahren realisieren wir photorealistische Drucke.

- Hochauflösender Fotodruck
- Brillante Farben
- Verbindlicher Farbproof vorab

With the PREMIUM PHOTO PRINT-process, we create photorealistic prints.

- very detailed photoprints
- brilliant colours
- binding paper colour proof in advance.

Grâce au procédé PREMIUM PHOTO PRINT, nous réalisons des impressions photoréalistes.

- impression de photos de haute définition
- couleurs brillantes
- épreuve couleur sur papier préalable

Met de PREMIUM PHOTO PRINT-techniek realiseren we foto-realistische bedrukkingen.

- Hoge resolutie afbeeldingen
- Brillante kleuren
- Bindende Paper Colour Proof vooraf

GLOSSY IMPRESSION
PRINT



Mit dem GLOSSY IMPRESSION-Verfahren erscheint die Oberfläche des Glases im Wechselspiel von gefroreter und transparenter Optik. Dezent und harmonisch.

- Tolle Effekte
- Edle Werbefläche
- Patentrechtlich geschützt

The GLOSSY IMPRESSION process makes the surface of the glass an interplay between a frosted and transparent look. Subtle and harmonious.

- great effects
- premium advertising space
- covered by patents

Avec le système d'impression spécial GLOSSY IMPRESSION, la surface du verre apparaît changeante en alternant transparence et verre givré. Décence et harmonie.

- superbes effets
- superbe surface publicitaire
- système breveté

Met de speciale druktechniek GLOSSY IMPRESSION wisselt het oppervlak van het glas een frosted look af met een transparante. Ingetogen en harmonieus.

- Schitterende effecten
- Hoogwaardige reclamevlakken
- Gepatenteerd

**ALL
OVER+**
PRINT



D

Das ALL-OVER PRINT PLUS-Verfahren erreicht im Druck 99 % der Mug-Oberfläche.

- Vollkommene Flächen-nutzung
- Optimal individualisierbar
- Schon ab 108 Stück

GB

ALL-OVER PRINT PLUS process is designed to cover up to 99 % of the mug surface.

- complete use of surface area
- optimal personalization
- min. order qty. only 108 pcs.

F

Le procédé ALL-OVER PRINT PLUS permet l'impression de 99 % de la surface de la tasse.

- utilisation optimale de la surface
- personnalisation parfaite de votre tasse
- dès 108 pièces

NL

De ALL-OVER PRINT PLUS-methode bedekt middels bedrukking 99% van het oppervlak van de mok.

- Het gehele oppervlak wordt benut
- Optimaal te individualiseren
- Al vanaf 108 stuks

**DIRECT
PRINT**



Ohne große Umwege kommt unser DIRECT PRINT auf die Tasse und hat so die Nase vorn, wenn es um kurze Lieferzeiten geht.

- Kürzeste Lieferzeiten
- Kostengünstige Veredelung
- Stark bei Strichdrucken

Our DIRECT PRINT is applied on to the mug without any additional steps and it is therefore one step ahead whenever short lead times are required.

- very fast delivery
- inexpensive print
- perfect for line prints

L' impression directe sur les MUGS est réalisée sans intermédiaire : nous sommes ainsi capables de relever le défi en cas de délai de livraison urgent.

- livraison très vite
- décoration bon marché
- impression parfaite de traits

Zonder omwegen brengen we een DIRECT PRINT aan op de mok en staan op deze manier vooraan wanneer er een korte leverdatum gevraagd wordt.

- Snelle leveringen
- Voordelige bedrukkingen
- Ideaal voor volvlak bedrukking

**ALL
OVER
PRINT**



Das ALL-OVER PRINT-Verfahren bedruckt die Außenseite der Tasse rundum von Henkel bis Henkel und vom Rand bis zum Stand.

- Vollflächiger Druck
- Perfekte Individualisierbarkeit
- Große Werbefläche

The ALL-OVER PRINT-process prints the outside of your mug from handle to handle and from rim to base.

- printing all around the mug
- perfect individualisation
- large advertisement area

Le procédé ALL-OVER PRINT imprime intégralement la face extérieure de la tasse.

- impression de surface plane
- individualisation parfaite
- surface d'impression grande

De ALL-OVER PRINT-techniek bedrukt de buitenkant van de mok van oor tot oor en van top tot teen.

- Van top tot teen en van oor tot oor
- Perfect te individualiseren
- Groot drukformaat

**TRANSFER
PRINT**



Platzieren Sie starke Botschaften im TRANSFER PRINT. Durch die maximale Bedrukking wird die Vielfalt Ihrer Werbebotschaft perfekt transportiert.

- Unendliche Vielfalt
- Stark bei Rasterdrucken
- Perfekt in Verläufen

Place your intricate messages in the TRANSFER PRINT. By printing to the maximum surface of the mug, the diversity of your advertising message will be perfectly reproduced.

- endless variety
- perfect screen prints
- excellent halftone prints

Faites passer des messages fort, grâce à la technique d'impression par transfert. La tasse véhiculera ainsi parfaitement la diversité de votre message publicitaire.

- une diversité infinie
- impression parfaite de trames
- impression parfaite de graduations

Plaats een ijzersterke boodschap in TRANSFER PRINT. Door de maximale bedrukking van de mok wordt de veelzijdigheid van uw reclameboodschap perfect overgebracht.

- Enorme variatie
- Ideaal voor het drukken van rasters
- Ideaal voor het verloop van rasters

**POLYLUX
PRINT**



Das POLYLUX-Verfahren überzeugt mit leuchtenden Farben auf Porzellan, Glas und Edelstahl.

- CMYK möglich
- Kombinierbar mit COLOUR 4U
- Handspülung

The POLYLUX process puts an impressive finish on porcelain glass and stainless steel with its bright colours.

- CMYK possible
- can be combined with COLOUR 4U
- handwash only

Le procédé POLYLUX nous convainc par les couleurs lumineuses qu'il confère à la porcelaine, au verre et à l'acier inoxydable.

- quadrichromie (CMYK) possible
- combinable avec COLOUR 4U
- lavage à la main

De POLYLUX-methode overtuigt met sprekende kleuren op porselein, glas en edelstaal.

- CMYK mogelijk
- Te combineren met COLOUR 4U
- Handmatig afwassen

VERPACKUNGEN · PACKAGING

D

Tolle Tassen sollen sicher und schön verpackt sein! Ob einzeln, im 2er, 4er, 6er oder im richtig großen 36er Standard-Karton: Professionell verpackte Tassen und Teller machen einen perfekten Eindruck. Fragen Sie uns auch nach passenden Verpackungsschubern! Unser Angebot umfasst personalisierbare und individuelle Lösungen in diversen Größen. Sprechen Sie uns an!



P1A

Karton weiß für 1 Tasse
Maße:
~ 126 x 118 x 100 mm

GB

Great mugs should be packed attractively and safely! Whether packed individually, in packs of 2, 4, 6 or in a really big 36 mug standard box: Professionally packaged cups and plates make a perfect impression. Ask us about matching packaging slip cases as well! Our product offering includes customisable and individual solutions in various sizes. Talk to us!

F

L'emballage de jolies tasses doit être à la fois sympa et sécurisé, cela va de soi. Nous proposons différentes tailles de cartons: pour une unité, deux unités, quatre unités, six unités ou en grand format pour 36 unités. Un emballage professionnel crée toujours une bonne impression. N'hésitez pas à nous demander l'emballage qui vous convient! Nous vous proposons des solutions personnalisables et individuelles de différentes tailles. Contactez nous!

NL

Mooie mokken moeten veilig en fraai verpakt worden! Per stuk, per 2, 4, 6 of standaard per 36 in een grote doos: Professioneel verpakte mokken en borden maken een perfecte indruk. Vraag ons ook naar passende verpakkingswikkels! Ons aanbod omvat te personaliseren en individuele oplossingen in diverse formaten. We informeren u graag!

P1A

Cardboard box white for 1 cup
Size:
~ 126 x 118 x 100 mm

P1A

Carton blanc pour 1 tasse
Dimensions:
~ 126 x 118 x 100 mm

P1A

Doos wit voor 1 mok
Afmetingen:
~ 126 x 118 x 100 mm



P1B

Karton weiß mit Sichtfenster für 1 Tasse
Maße:
~ 121 x 93 x 117 mm

P1B

Cardboard box white with a window for 1 cup
Size:
~ 121 x 93 x 117 mm

P1B

Carton blanc avec couvercle vitré pour 1 tasse
Dimensions:
~ 121 x 93 x 117 mm

P1B

Doos wit met zichtvenster voor 1 mok
Afmetingen:
~ 121 x 93 x 117 mm



DUO ESPRESSO

Karton weiß für 2 Espresso Sets
Maße:
~ 132 x 132 x 110 mm

DUO ESPRESSO

Cardboard box white for 2 espresso sets
Size:
~ 132 x 132 x 110 mm

DUO ESPRESSO

Carton blanc pour 2 sets espresso
Dimensions:
~ 132 x 132 x 110 mm

DUO ESPRESSO

Doos wit voor 2 espresso sets
Afmetingen:
~ 132 x 132 x 110 mm



SET VERPACKUNG

Karton weiß für 1 oder 2 Sets
Maße:
~ 173 x 158 x 172 mm

SET PACKAGING

Cardboard box white for 1 or 2 sets
Size:
~ 173 x 158 x 172 mm

SET EMBALLAGE

Carton blanc pour 1 ou 2 sets
Dimensions:
~ 173 x 158 x 172 mm

SET VERPAKKING

Doos wit voor 1 of 2 sets
Afmetingen:
~ 173 x 158 x 172 mm

EMBALLAGE · VERPAKKINGEN



P2
Karton
weiß
für 2 Tassen
Maße:
~ 220 x 120 x 98 mm

P2
Cardboard box
white
for 2 cups
Size:
~ 220 x 120 x 98 mm

P2
Carton
blanc
pour 2 tasses
Dimensions:
~ 220 x 120 x 98 mm

P2
Doos
wit
voor 2 mokken
Afmetingen:
~ 220 x 120 x 98 mm



P4
Karton
weiß
für 4 Tassen
Maße:
~ 217 x 217 x 122 mm

P4
Cardboard box
white
for 4 cups
Size:
~ 217 x 217 x 122 mm

P4
Carton
blanc
pour 4 tasses
Dimensions:
~ 217 x 217 x 122 mm

P4
Doos
wit
voor 4 mokken
Afmetingen:
~ 217 x 217 x 122 mm



P6
Karton
weiß
für 6 Tassen
Maße:
~ 325 x 217 x 122 mm

P6
Cardboard box
white
for 6 cups
Size:
~ 325 x 217 x 122 mm

P6
Carton
blanc
pour 6 tasses
Dimensions:
~ 325 x 217 x 122 mm

P6
Doos
wit
voor 6 mokken
Afmetingen:
~ 325 x 217 x 122 mm



P36
Standard-Karton
braun
für 36 Tassen
Maße:
~ 440 x 340 x 360 mm

P36
Standard box
brown
for 36 cups
Size:
~ 440 x 340 x 360 mm

P36
Carton standard
marron
pour 36 tasses
Dimensions:
~ 440 x 340 x 360 mm

P36
Standaard doos
bruin
voor 36 mokken
Afmetingen:
~ 440 x 340 x 360 mm



Verpackungsschuber
individuell personalisierbar
Größen und Druckfläche:
auf Anfrage

Geeignet für die
Verpackungen:
Standard P1A
Standard P2
P1A für 0975/0976
P2 für 0975/0976

Packaging slip cases
Individually customisable
Sizes and print area:
upon request

Suitable for packaging:
Standard P1A
Standard P2
P1A for 0975/0976
P2 for 0975/0976

Emballages emboîtés
personnalisables
**Tailles et surfaces
d'impression:**
à la demande

Convient aux emballages
suivants:
Standard P1A
Standard P2
P1A pour 0975/0976
P2 pour 0975/0976

Verpakkingswikkels
individueel te personaliseren
Formaten en drukvlakken:
op aanvraag

Geschikt voor de
verpakkingen:
Standaard P1A
Standaard P2
P1A voor 0975/0976
P2 voor 0975/0976



designed to brand