

2010 Deutsch Français  
English Nederlands

# PEN COLLECTION

senator®

designed to brand



# PEN COLLECTION

---

## PLASTIC PENS



**AKZENTO**  
2762 BASIC > 52  
2760 ICY > 50



**DUO-PEN**  
2122 > 24

**NEW**



**ANTIBAC**  
2645 > 40



**HATTRIX**  
2177 BASIC > 39



2178 SOFT > 39



2339 SOFT CLEAR > 37



2179 METAL > 36



2419 METAL CLEAR > 37



**@TRACT**  
2512 BASIC > 15



2513 METAL > 14



**BIG PEN**  
1133 > 32



1177 ICY > 30



1171C BIG MESSAGE > 34



**MATRIX**  
2318 BASIC > 17



2319 CLEAR > 17



2321 METAL > 17

**NEW**



2721 CLASSIC > 16



**CHALLENGER**  
2519 ALU > 49



2416 BASIC > 48



2418 ICY > 47



2417 SOFT > 44



2597 SOFT CLEAR > 45



2926 XL METALLIC > 43



2925 XL CLEAR > 42



**NATURE PLUS**  
2796 > 13



**DART**  
2600 BASIC > 63



2602 CLEAR > 63



**NEW SPRING**  
2303 BASIC > 22



2431 CHROME > 18



2561 CHROME CLEAR > 19



2426 CLEAR > 20



2410 METAL CLEAR > 21



2310 METALLIC > 23

## POINT



2362 BASIC > 55



2866 METAL > 54



2590 PLUS > 55

## SKEYE



2734 BASIC > 28



2732 CLEAR > 26

**NEW**



2736 ICY > 29



2733 XL CLEAR > 27

**NEW**



2739 XL ALU > 29

## SOFT-SPRING



2067 > 25

## SOFTSTAR



2511 ALU > 66



2040 STEEL > 66

## SUNNY



2725 BASIC > 60



2726 CLEAR > 61

## SUPER-HIT



2883 BASIC > 59

**NEW**



2850 ECO > 12



2244 ICY > 59

## SUPER-SOFT



2274 BASIC > 56



2234 CLEAR > 57

## METAL PENS

### CARBON-LINE



> 84

### DELGADO



CLASSIC > 68



METALLIC > 70



STEEL > 70

### IMAGE



CHROME > 78



CLASSIC > 76

**NEW**



BLACK LINE > 78

### LEGACY

**NEW**



> 75

### NAUTIC



> 74

### PRESIDENT



> 88

### SILVER-LINE



> 86

### SOLARIS



> 81



CHROME > 80

### TIZIO



> 82

### VISIR



> 73

ETUIS · CASES · ETUIS · ETUIS  
> 90 - 91



MINEN · REFILLS · RECHARGES · VULLINGEN  
> 95



TECHNIK · TECHNIQUE · TECHNIQUE · TECHNIK  
> 92 - 94

# News



SKEYE ICY



SKEYE XL ALU

**D**

Es ist die persönlichste Form der Kommunikation: das Verfassen von Texten mit einem hochwertigen Schreibgerät. SENATOR überrascht jedes Jahr auf's Neue mit innovativen Produktideen.

So besticht der **SKEYE ICY** durch ein transparent, mattes Kunststoffgehäuse. Genauso wirkungsvoll in seiner Optik ist der silberfarbenen lackierte **SKEYE XL ALU**. Der Clou der SKEYE-Schreibgeräte: Aufgrund ihrer raffinierten Form zeigt die Werbebotschaft immer nach oben! Ein absoluter „Must have“: der **IMAGE BLACK!** Das markante Design mit schwarz verchromten Metallbeschlägen bringt den schwarzen Klassiker stilvoll zur Geltung, ein Eindruck, der durch eine Lasergravur noch verstärkt wird. Ein angenehmes Schreibgefühl verspricht auch der neue **LEGACY** mit einer besonders großen Softgriffzone.

**GB**

This is the most personal form of communication, writing with a high-quality writing instrument. SENATOR produces new surprises every year with innovative product ideas. **SKEYE ICY** is such a product, with its transparent, matt plastic barrel. As attractive in appearance is the **SKEYE XL ALU**. Due to its unique barrel geometry, the barrel branding is always visible. A “must have”: the **IMAGE BLACK!** The striking design with black chrome metal fittings sets off this black classic perfectly, an impression which is enhanced even further with laser engraving. Fitted with a specially large soft grip, the **LEGACY** also guarantees a pleasant writing experience.

**F**

C'est la forme de communication la plus personnelle qui soit : la rédaction de textes avec un instrument d'écriture haut de gamme. SENATOR surprend à nouveau chaque année par ses idées de produits innovantes. Ainsi, **SKEYE ICY** séduit par sa gaine en matière plastique transparente mate. **SKEYE XL ALU** laqué de couleur argentée présente une ligne pareillement efficace. Le clou des stylos à bille **SKEYE** : une forme raffinée qui fait que le message publicitaire est toujours dirigé vers le haut ! Le « Must have » absolu : **IMAGE BLACK !** La ligne marquante aux applications métalliques de couleur noir chromé met en valeur le classique noir avec beaucoup de style, impression qui est encore renforcée par une gravure au laser. Une sensation d'écriture agréable, telle est aussi la promesse de **LEGACY** avec sa zone soft particulièrement grande.

**NL**

De meest persoonlijke vorm van communicatie: het schrijven van teksten met hoogwaardig schrijfgerei. SENATOR verrast elk jaar opnieuw met innovatieve productideeën. Zo bekoort de **SKEYE ICY** door een transparante, matte kunststofbehuizing. Al even indrukwekkend is de verschijningsvorm van de zilverkleurig gelakte **SKEYE XL ALU**. De clou van de **SKEYE** pennen: dankzij de geraffineerde vormgeving verschijnt de reclameboodschap altijd in beeld! Een absolute „Must have“: de **IMAGE BLACK!** Het opvallende design, met zwart verchromd metaalbeslag maakt van de zwarte klassieker een stijlvol schrijfinstrument. Een indruk die door een lasergravure nog versterkt wordt. Een aangenaam schrijfgevoel belooft ook de **LEGACY**, met zijn bijzonder grote softgripzone.

IMAGE BLACK

LEGACY



# senator

Germany

Great Britain

France

Poland

Russia

Netherlands

USA

India

China



## D

SENATOR steht seit 90 Jahren für Qualität, Innovation und Nachhaltigkeit. Das Leitmotiv der Gründer hat noch heute Gültigkeit: „Ideen und Produkte, die anders sind als andere“. Unverändert ist der Innovationsgeist und das Bestreben, immer eine Idee besser zu sein. Dafür greifen wir auf Jahrzehnte lange Tradition und Erfahrung zurück.

Das Ziel, Ökologie und Ökonomie in Einklang zu bringen, ist bei SENATOR allgegenwärtig. Es wird durch alle Funktionen des Unternehmens hinweg getragen. Im Rahmen eines anspruchsvollen Umweltmanagement-Systems unterziehen wir unsere Prozesse einer regelmäßigen Überprüfung, integrieren neue Erkenntnisse und passen uns wichtigen Veränderungen aktiv an. Daher kommen für unsere Produkte auch nur Rohstoffe zum Einsatz, die einer umfangreichen ökologischen Bewertung standhalten.

Werkstoffauswahl und Produktionsprozesse sind auf Schadstofffreiheit, Verwendung von Recyclingmaterial, biologische Abbaubarkeit und Abfallvermeidung ausgerichtet. Die Einhaltung der REACH-Verordnung der Europäischen Union, die besagt, dass bis 2018 nur noch geprüfte und registrierte Chemikalien verwendet werden, erfüllen wir damit schon jetzt.

Als ISO 9001-zertifiziertes Unternehmen leisten wir nicht nur in jedem einzelnen Bereich geprüfte und verbriefte Qualität, SENATOR verpflichtet sich auch in einem eigens entwickelten SER-Programm (Social & Environmental Responsibility) und im Rahmen der weltweiten „Business Social Compliance Initiative“ (BSCI), in der wir Mitglied sind, ausdrücklich Verantwortung für Menschen und Umwelt zu übernehmen.

## GB

SENATOR has stood for quality, innovation and sustainability for 90 years. The guiding principle of the founders still remains valid: "Ideas and products which are different from others". The spirit of innovation, and the drive to always be one idea ahead remains unchanged. For these purposes we can fall back on decades of tradition and experience.

The goal of conciliating ecology and economy is ingrained throughout SENATOR, and is supported by all functions of the company. As part of an exacting environmental management system, we subject our processes to regular review, integrate new knowledge and actively adapt ourselves to major changes. For our products we only use raw materials which stand up to comprehensive ecological assessment.

Selection of raw materials and production processes are directed towards ensuring the absence of hazardous materials, use of recycled material, bio-degradability and avoidance of waste. We therefore comply with the REACH ordinance of the European Union, which states that only tested and registered chemicals must be used by the year 2018.

As a company certified to ISO 9001, SENATOR not only delivers tested and certified quality in every individual area, but has also committed itself to assume responsibility for people and the environment as part of its own CSR program (Corporate Social Responsibility) and also as member of the worldwide "Business Social Compliance Initiative" (BSCI).

## PEN COLLECTION



## MUGS BY roubill



## WRITING ACCESSORIES



F

SENATOR est associée à la notion de qualité, d'innovation et de durabilité depuis 90 ans. Le principe directeur des fondateurs de l'entreprise est aujourd'hui encore d'actualité : « Des idées et produits différents des autres ». Rien n'a également changé en matière d'esprit d'innovation et de volonté d'avoir toujours une idée d'avance. Voilà pourquoi nous nous appuyons sur une tradition et une expérience de plusieurs décennies.

L'objectif, à savoir mettre écologie et économie au diapason, est omniprésent chez SENATOR. Il se retrouve dans toutes les fonctions de l'entreprise tel un fil directeur. Nous soumettons nos process à un contrôle régulier, leur intégrons les nouveaux acquis et nous adaptons activement aux changements importants survenus dans le cadre d'un système ambitieux de gestion de l'environnement. C'est pourquoi seules les matières premières jugées aptes dans le cadre d'une évaluation écologique complète entrent dans la fabrication de nos produits.

Le choix des matériaux et les process de production sont basés sur l'absence de substances nocives, l'utilisation de produits recyclés, la biodégradabilité et le moins de déchets possibles. Nous répondons ainsi aux attentes du décret REACH de l'Union Européenne, qui impose l'utilisation exclusive de produits chimiques contrôlés et enregistrés jusqu'en 2018.

En qualité d'entreprise certifiée ISO 9001, SENATOR ne contribue pas seulement à une qualité contrôlée et attestée dans chaque domaine individuel ; en effet, l'entreprise s'engage également, dans un programme SER qu'elle a elle-même initié (Social&EnvironmentalResponsibility) et, dans le cadre de la BSCI mondiale (Business SocialCompliance Initiative), en exprimant ses responsabilités envers l'homme et l'environnement.

NL

SENATOR staat al 90 jaar garant voor kwaliteit, innovatie en duurzaamheid. Het motto van de oprichters heeft nog niets aan geldigheid ingeboet: 'Ideeën en producten die anders zijn dan de andere'. De zin voor innovatie en de doelstelling om altijd een beter idee te hebben, is onveranderd. Daarbij grijpen wij terug op tientallen jaren traditie en ervaring.

Het doel om ecologie en economie met elkaar te verzoenen, is bij SENATOR alom tegenwoordig. Het wordt in alle geledingen van de onderneming gesteund. In het kader van een veeleisend milieumanagementsysteem onderwerpen wij onze processen aan regelmatige controles, integreren nieuwe inzichten en passen ons actief aan belangrijke veranderingen aan. Daarom worden voor onze producten ook uitsluitend grondstoffen gebruikt die een omvangrijke ecologische beoordeling hebben doorstaan.

De selectie van materialen en productieprocessen is op de afwezigheid van schadelijke stoffen, het gebruik van recyclingmateriaal, biologische afbreekbaarheid en afvalvermindering afgestemd. De naleving van de REACH-verordening van de Europese Unie, die zegt dat vanaf 2018 uitsluitend nog geteste en geregistreerde chemicaliën gebruikt mogen worden, is bij ons nu al een feit.

Als ISO 9001-gecertificeerde onderneming leveren wij niet alleen in elk afzonderlijk gebied geteste en schriftelijk vastgelegde kwaliteit, SENATOR verbindt zich er ook toe via een eigen ontwikkeld SER-programma (Social&EnvironmentalResponsibility, Sociale en ecologische verantwoordelijkheid) en in het kader van het wereldwijde, Business SocialCompliance Initiative' (BSCI), uitdrukkelijk verantwoordelijkheid voor mens en milieu te nemen.



# ÜBERSICHT · OVERVIEW · APERÇU · OVERZICHT

## MODELLE

Bunt, trendy, preiswert. Die idealen Streuartikel für kleine Budgets.

## MODELS

Colourful, trendy, economical. The ideal give-aways for small budgets.

## MODÈLES

Multicolore, très tendance, économique. L'article à distribuer idéal pour les petits budgets.

## MODELLEN

Kleurrijk, trendy, scherp geprijsd. De ideale strooiartikelen voor kleine budgetten.



**DART**  
2600 BASIC  
> 63



**DART**  
2602 CLEAR  
> 63



**SUNNY**  
2725 BASIC  
> 60



**SUNNY**  
2726 CLEAR  
> 61



**SUPER-HIT**  
2883 BASIC  
> 59



**SUPER-HIT**  
2850 ECO  
> 12



**SUPER-HIT**  
2244 ICY  
> 59



**POINT**  
2362 BASIC  
> 55



**POINT**  
2590 PLUS  
> 55



**SUPER SOFT**  
2274 BASIC  
> 56



**SUPER-SOFT**  
2234 CLEAR  
> 57



**CHALLENGER**  
2416 BASIC  
> 48



**CHALLENGER**  
2417 SOFT  
> 44



**HATTRIX**  
2177 BASIC  
> 39



**HATTRIX**  
2178 SOFT  
> 39



**AKZENTO**  
2762 BASIC  
> 52



**AKZENTO**  
2760 ICY  
> 50



**MODELLE**

Aufmerksamkeitsstarke Designs für mehr  
Werbewirkung.

**MODELS**

Striking designs for greater advertising effect.

**MODÈLES**

Des lignes qui captent l'attention pour plus  
d'effet publicitaire.

**MODELLEN**

Opvallend design voor meer reclame-effect.



**CHALLENGER**  
2418 ICY  
> 47



**CHALLENGER**  
2597 SOFT CLEAR  
> 45



**CHALLENGER**  
2519 ALU  
> 49



**CHALLENGER**  
2926 XL METALLIC  
> 43



**CHALLENGER**  
2925 XL CLEAR  
> 42



**ANTIBAC**  
2645  
> 40



**SKEYE**  
2734 BASIC  
> 28



**SKEYE**  
2736 ICY  
> 29



**SKEYE**  
2732 CLEAR  
> 26



**BIG PEN**  
1133  
> 32



**BIG PEN**  
1177 ICY  
> 30



**BIG MESSAGE PEN**  
1171  
> 32



**HATRIX**  
2339 SOFT CLEAR  
> 37



**HATRIX**  
2179 METAL  
> 36



**HATRIX**  
2419 METAL CLEAR  
> 37



**NEW SPRING**  
2303 BASIC  
> 22



**NEW SPRING**  
2426 CLEAR  
> 20



**NATURE PLUS**  
2796  
> 13



**POINT**  
2866 METAL  
> 54

# ÜBERSICHT · OVERVIEW · APERÇU · OVERZICHT

## MODELLE

Kunststoff und Metall  
raffiniert kombiniert.

## MODELS

The elegant combination  
of plastic and metal.

## MODÈLES

Le raffinement de la matière plastique  
et du métal combinés.

## MODELLEN

Kunststof en metaal  
geraffineerd gecombineerd.



**NEW SPRING**  
2410 METAL CLEAR  
> 20



**NEW SPRING**  
2310 METALLIC  
> 23



**NEW SPRING**  
2431 CHROME  
> 18



**NEW SPRING**  
2561 CHROME CLEAR  
> 19



**SKEYE**  
2733 XL CLEAR  
> 27



**SKEYE**  
2739 XL ALU  
> 29



**DUO PEN**  
2122  
> 24



**SOFT SPRING**  
2067  
> 25



**@TRACT**  
2512 BASIC  
> 15



**@TRACT**  
2513 METAL  
> 14



**MATRIX**  
2318 BASIC  
> 16



**MATRIX**  
2319 CLEAR  
> 17



**MATRIX**  
2321 METALLIC  
> 17



**MATRIX**  
2721 CLASSIC  
> 16



**SOFTSTAR**  
2040 STEEL  
> 66



**SOFTSTAR**  
2511 ALU  
> 66

#### MODELLE

Metallschreibgeräte, einzeln oder im Set  
- unwiderstehlich elegant und hochwertig.

#### MODELS

Metal writing instruments, individually or as  
a set, irresistibly elegant and sophisticated.

#### MODÈLES

Instruments d'écriture métalliques,  
individuels ou en kits, irrésistiblement  
élégants et de grande qualité.

#### MODELLEN

Metalen schrijfgerei, afzonderlijk of als set,  
onweerstaanbaar elegant en hoogwaardig.



**DELGADO  
CLASSIC**  
> 69



**DELGADO  
CHROME**  
> 71



**LEGACY  
2788 BASIC**  
> 75



**NAUTIC**  
> 74



**VISIR**  
> 73

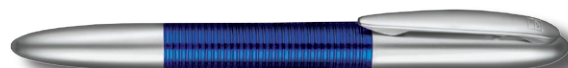

**SOLARIS**  
> 81

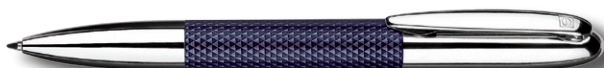

**SOLARIS CHROME**  
> 80



**SILVER-LINE**  
> 87



**IMAGE  
CLASSIC**  
> 77



**IMAGE  
CHROME**  
> 79



**IMAGE  
BLACK LINE**  
> 79



**TIZIO**  
> 83



**CARBON-LINE**  
> 85



**PRESIDENT**  
> 89

# PLASTIC PENS

---

Ein perfekter Mix: Farbenfroh und ein junges, dynamisches Design – die kunterbunten Kugelschreiber gleiten besonders trendy über das Papier. Ein Schreibgerät, das Spaß macht – jeden Tag.

A perfect mix: brightly coloured with a young, dynamic design – high function ballpens which glide effortlessly over the paper.

Un mélange parfait : haut en couleur et une ligne dynamique et résolument jeune – les stylos-bille multicolores pour une glisse tendance sur le papier. Un instrument d'écriture qui fait plaisir – tous les jours.

Een perfecte combinatie: kleurenrijkdom en een jong, dynamisch design – de veelkleurige balpennen flitsen trendy over het papier. Schrijven met plezier – elke dag.





D

**SUPER-HIT ECO**

Druckkugelschreiber, schwarz  
Schaft aus 95 % Recyclingmaterial  
Qualitätsmine,  
blau oder schwarz

**NATURE PLUS**

Druckkugelschreiber  
aus biologisch abbaubarem Kunststoff  
nicht über 50°C lagern  
Qualitäts-Großraummine,  
blau oder schwarz

GB

**SUPER-HIT ECO**

Retractable ballpen, black  
Barrel of 95 % recycled material  
Quality refill,  
blue or black

**NATURE PLUS**

Retractable ballpen  
Genuinely biodegradable  
from renewable resources  
Do not store in temperatures  
above 50° C  
Large capacity quality refill,  
blue or black

F

**SUPER-HIT ECO**

Stylo à bille rétractable, noir,  
Corps en plastique recyclé à 95 %,  
Recharge de qualité,  
bleue ou noire

**NATURE PLUS**

Stylo à bille rétractable,  
En matière biodégradable,  
Ne pas entreposer à une température  
supérieure à 50° C  
Recharge de qualité de grande capacité,  
bleue ou noire

NL

**SUPER-HIT ECO**

Balpen, zwart met gekleurde clip  
Houder van 95% recycling materiaal  
Kwaliteitsvulling,  
blauw- of zwartschrijvend

**NATURE PLUS**

Balpen  
Biologisch afbreekbaar materiaal  
Niet blootstellen aan temperaturen  
boven 50° C  
Kwaliteits-longschrijfvulling, blauw-,  
of zwartschrijvend

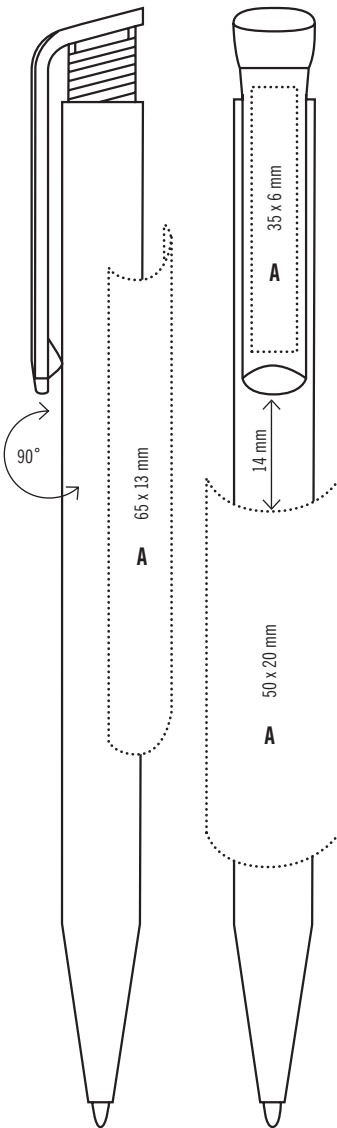

**SPECIAL FEATURE:**

- > Schaft aus 95 % Recycling-Material
- > barrel of 95 % recycled material
- > 95 % du corps du stylo est en plastique recyclé
- > Houder van 95% recycling materiaal



**A**  
SCREEN  
PRINT

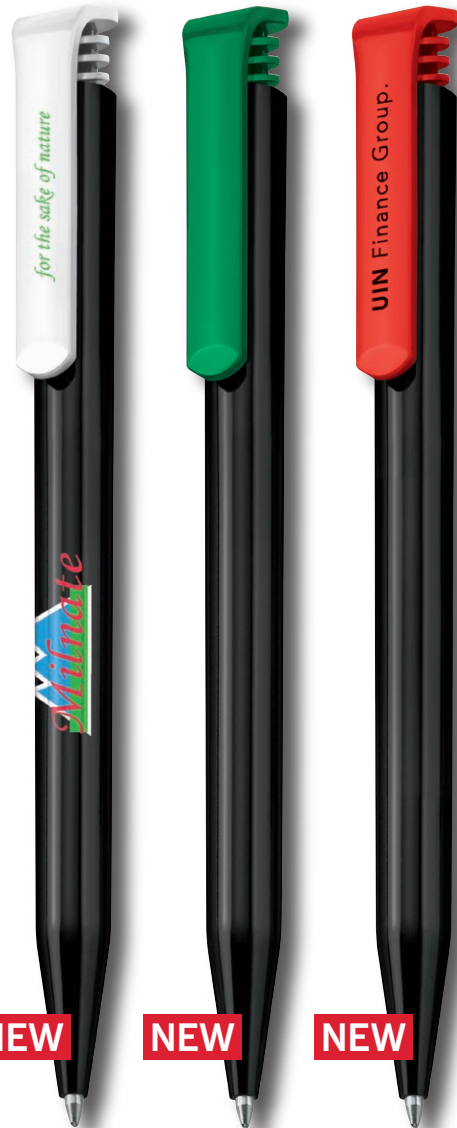

**2850 SUPER HIT ECO**

Farben · Colours · Coloris · Kleuren

- white
- PMS 116 C
- PMS 485 C
- PMS 349 C
- PMS 2935 C

# SUPER-HIT ECO NATURE PLUS

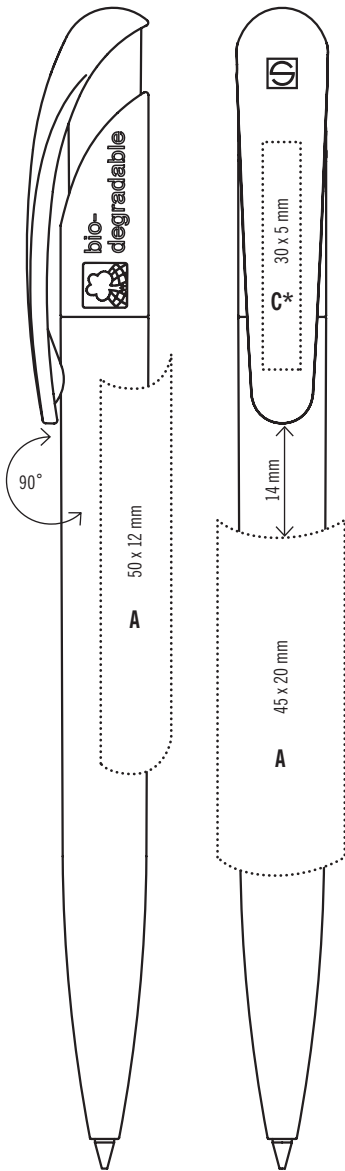

## SPECIAL FEATURE:

- > biologisch abbaubar
- > zertifiziert nach DIN Certco
- > aus nachwachsenden Rohstoffen
  
- > genuinely biodegradable
- > DIN certified
- > from renewable resources
  
- > en matière biodégradable
- > certifié DIN Certco
- > matières premières renouvelables
  
- > biologisch afbreekbaar
- > DIN Certco gecertificeerd
- > grondstoffen geschikt voor hergebruik



## 2796 NATURE PLUS

Farben · Colours · Coloris · Kleuren



natural  
PMS 288 C  
PMS 349 C  
PMS 485 C  
PMS 123 C

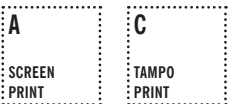

- \* nur 1-farbig
- \* 1 colour only
- \* 1 couleur seulement
- \* uitsluitend in 1 kleur

GEL  
OPTION

D

Drehkugelschreiber  
versenkbarer Sicherheitsclip  
aus Metall  
Qualitäts-Großraummine,  
blau oder schwarz

**METAL**

metallicfarbenes Gehäuse  
Metallspitze

**BASIC**

opakes Gehäuse

GB

Twist-mechanism ballpen  
Retractable security clip  
of glossy metal  
Large capacity quality refill,  
blue or black

**METAL**

Metallic coloured barrel  
Metal tip

**BASIC**

Opaque barrel

F

Stylo à bille à mécanisme tournant,  
Clip de sécurité rétractable en métal,  
Recharge de qualité de grande capacité,  
bleue ou noire

**METAL**

Corps aspect métallisé,  
Pointe en métal brillant

**BASIC**

corps opaque

NL

Balpen met draaimechaniek  
Geïntegreerde veiligheidsclip  
van metaal  
Kwaliteits-longschrijfvulling,  
blauw-, of zwartschrijvend

**METAL**

Houder in metallic look  
Metalen punt

**BASIC**

Opake houder

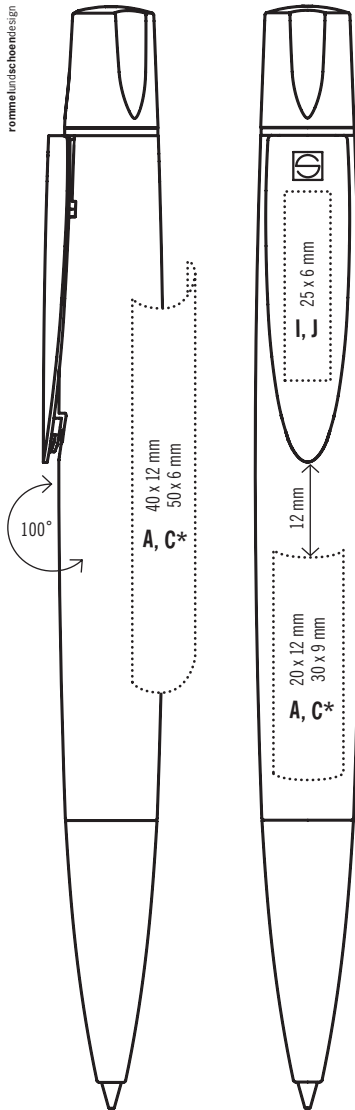

reddot design award  
winner 2006



DESIGNPREIS  
2007  
NOMINEE  
Developpede van BDD  
Design Award of the FFG



As certified by The Chicago Athenaeum  
Museum of Architecture and design



<b>A</b> SCREEN PRINT	<b>C</b> TAMPO PRINT
<b>I</b> ETCHING	<b>J</b> LASER ENGRAVING

- \* nur 1-farbig
- \* 1 colour only
- \* 1 couleur seulement
- \* uitsluitend in 1 kleur



**2513 METAL**

Farben · Colours · Coloris · Kleuren





SPECIAL FEATURE:



**2512 BASIC**

Farben · Colours · Coloris · Kleuren

- |  |           |
|--|-----------|
|  | PMS white |
|  | PMS 123 C |
|  | PMS 485 C |
|  | PMS 288 C |
|  | black     |

**D**

Druckkugelschreiber  
ergonomische Softgriffzone  
Qualitäts-Großraummine,  
blau oder schwarz

**CLASSIC**  
vergoldeter Clip

**BASIC**  
weißes Kunststoffgehäuse

**METALLIC**  
metallicfarbenes Gehäuse

**CLEAR**  
glänzend transparentes Gehäuse

**GB**

Retractable ballpen  
Ergonomic soft grip section  
Large capacity quality refill,  
blue or black

**CLASSIC**  
Gilt clip

**BASIC**  
white, opaque barrel

**METALLIC**  
Metallic coloured barrel

**CLEAR**  
High gloss translucent barrel

**F**

Stylo à bille rétractable,  
Zone de préhension ergonomique  
souple,  
Recharge de qualité de grande capacité,  
bleue ou noire

**CLASSIC**  
Clip en métal doré

**BASIC**  
Corps en plastique blanc

**METALLIC**  
Corps en couleur métallisée

**CLEAR**  
Corps transparent brillant

**NL**

Balpen  
Ergonomische softgripzone  
Kwaliteits-longschrijfvulling,  
blauw-, of zwartschrijvend

**CLASSIC**  
Vergulde clip

**BASIC**  
Witte kunststof houder

**METALLIC**  
Houder in metallic kleuren

**CLEAR**  
Glanzend transparante houder

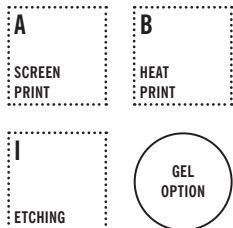
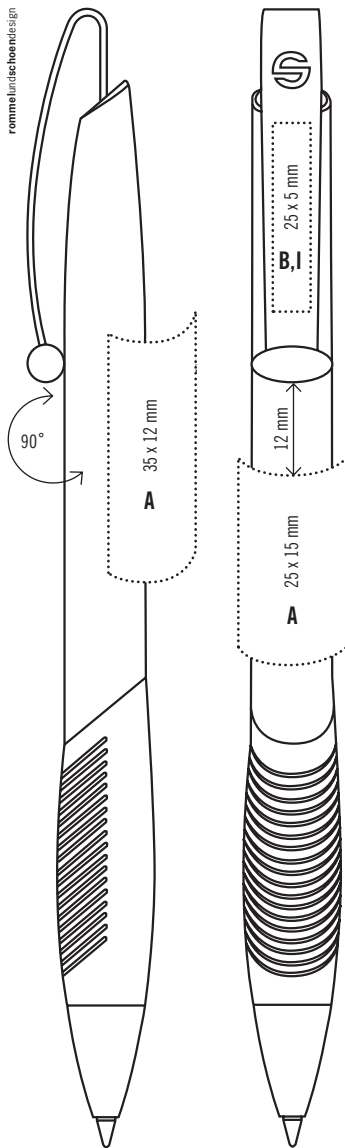

- \* nur bei 2318, 2319, 2321
- \* only on 2318, 2319, 2321
- \* seulement sur 2318, 2319, 2321
- \* alleen bij 2318, 2319, 2321

**2721 CLASSIC**

Farben · Colours · Coloris · Kleuren  
PMS black

# MATRIX



## 2318 BASIC

Farben · Colours · Coloris · Kleuren

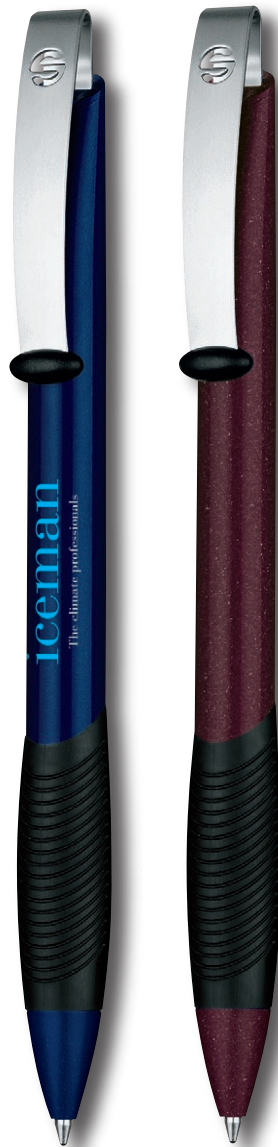
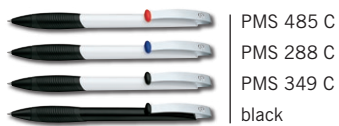

## 2321 METALLIC

Farben · Colours · Coloris · Kleuren



## 2319 CLEAR

Farben · Colours · Coloris · Kleuren



D

preisgekrönter Druckkugelschreiber  
originelle Kappendruckmechanik  
massives Metallvorderteil  
Qualitäts-Großraummine,  
blau oder schwarz

**CHROME**

metallfarbenes Oberteil

**CHROME CLEAR**

glänzend transparentes Oberteil

GB

Award-winning retractable ballpen  
Innovative push-cap-mechanism  
Solid metal front part  
Large capacity quality refill,  
blue or black

**CHROME**

Metallic colour upper part

**CHROME CLEAR**

High gloss translucent upper part

F

Stylo à bille rétractable,  
Mécanisme de pression sur capuchon  
original,  
Embout en métal solide,  
Recharge de qualité de grande capacité,  
bleue ou noire

**CHROME**

partie haute en couleur métallisée

**CHROME CLEAR**

partie haute translucide et brillant

NL

Meermaals bekrone balpen  
Origineel schuifkapmechaniek  
Massief metalen houder  
Kwaliteits-longschrijfvulling,  
blauw-, of zwartschrijvend

**CHROME**

Kap in metallic look

**CHROME CLEAR**

Glanzend transparante kap

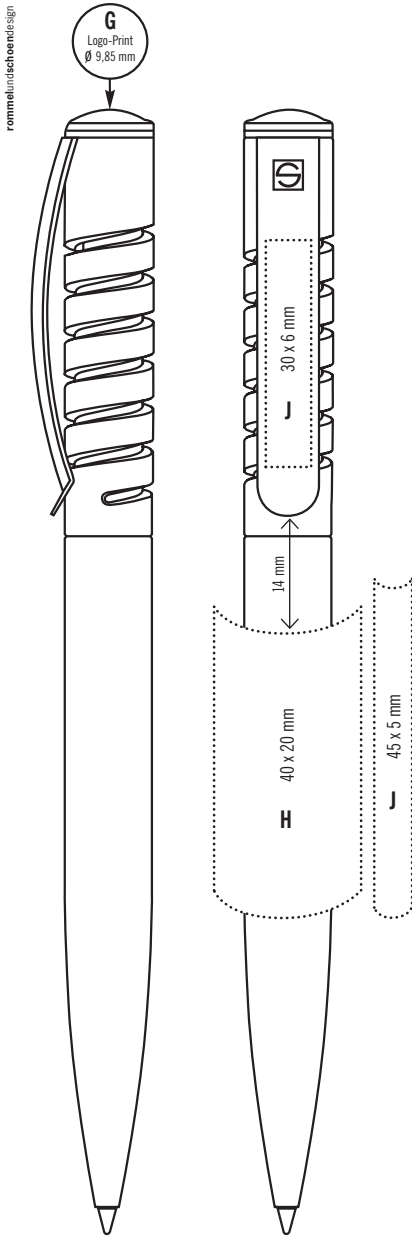

reddot design award  
winner 2006



DESIGNPREIS  
2007  
NOMINEE  
Designpreis der BPD  
Design Award of the BPD



As awarded by The Chicago Athenaeum  
Museum of Architecture and Design

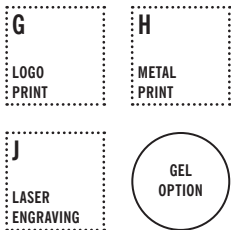

**2431 CHROME**

Farben · Colours · Coloris · Kleuren



# NEW SPRING



**NEW**

**NEW**

**NEW**

**NEW**

**NEW**

SPECIAL FEATURE:



LOGO PRINT

## 2561 CHROME CLEAR

Farben · Colours · Coloris · Kleuren

-  PMS 1225 C
-  PMS 1505 C
-  PMS 201 C
-  PMS 347 C
-  PMS 286 C
-  PMS 281 C
-  PMS 267 C
-  PMS 418 C

D

preisgekrönter Druckkugelschreiber  
originelle Kappendruckmechanik  
Qualitäts-Großraummine,  
blau oder schwarz

**CLEAR**

glänzend transparentes  
Kunststoffgehäuse und -clip

**METAL CLEAR**

glänzend transparentes  
Kunststoffgehäuse, Metallclip

GB

Award-winning retractable ballpen  
Innovative push-cap-mechanism  
Large capacity quality refill,  
blue or black

**CLEAR**

High gloss transparent plastic barrel  
and clip

**METAL CLEAR**

High gloss transparent plastic barrel,  
metal clip

F

Stylo à bille rétractable,  
Mécanisme de pression sur capuchon  
original,  
Recharge de qualité de grande capacité,  
bleue ou noire

**CLEAR**

Corps et clip transparents brillants

**METAL CLEAR**

Corps translucide brillant,  
Clip en métal

NL

Meermals bekoonde balpen  
Origineel schuifkapmechaniek  
Kwaliteits-longschrijfvulling,  
blauw-, of zwartschrijvend

**CLEAR**

Glanzend transparante kunststof houder  
en clip

**METAL CLEAR**

Glanzend transparante kunststof  
houder, metalen clip

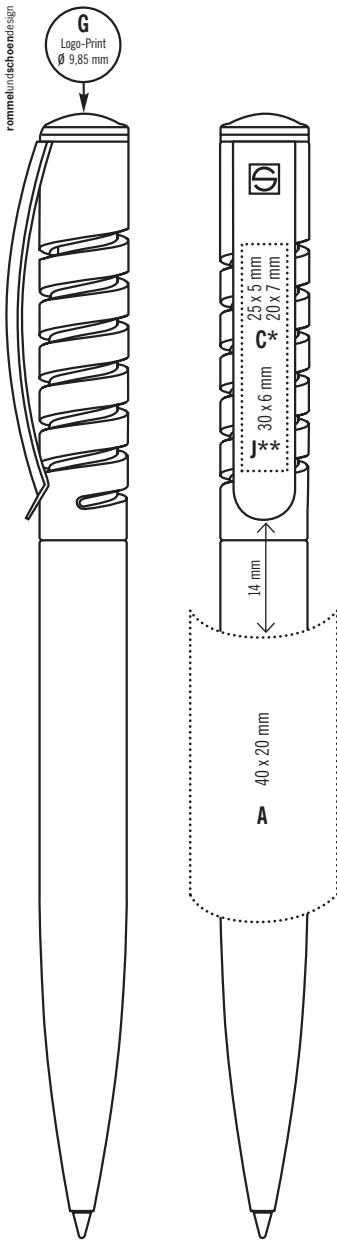

<b>A</b> SCREEN PRINT	<b>C</b> TAMPO PRINT
<b>G</b> LOGO PRINT	<b>J</b> LASER ENGRAVING

- \* nur bei 2426
- \*\* nur bei 2410
- \* only on 2426
- \*\* only on 2410
- \* seulement sur 2426
- \*\* seulement sur 2410
- \* alleen bij 2426
- \*\* alleen bij 2410



**2426 CLEAR**

Farben · Colours · Coloris · Kleuren

- PMS 1225 C
- PMS 1505 C
- PMS 201 C
- PMS 347 C
- PMS 286 C
- PMS 281 C
- PMS 267 C
- PMS 418 C

# NEW SPRING



SPECIAL FEATURE:



LOGO PRINT

## 2410 METAL CLEAR

Farben · Colours · Coloris · Kleuren



**D**

preisgekrönter Druckkugelschreiber  
originelle Kappendruckmechanik  
Qualitäts-Großraummine,  
blau oder schwarz

**BASIC**  
glänzend opakes Kunststoffgehäuse

**METALLIC**  
Kunststoffgehäuse in Metallicfarben,  
Metallicclip

**GB**

Award-winning retractable ballpen  
Innovative push-cap-mechanism  
large capacity quality refill,  
blue or black

**BASIC**  
Gloss opaque plastic barrel

**METALLIC**  
Metallic coloured barrel  
Metal clip

**F**

Stylo à bille rétractable,  
Mécanisme de pression sur capuchon  
original,  
Recharge de qualité de grande capacité,  
bleue ou noire

**BASIC**  
Corps opaque brillant

**METALLIC**  
Corps en couleur métallisée,  
Clip en métal

**NL**

Meermaals be kroonde balpen  
Origineel schuifkapmechaniek  
Kwaliteits-longschrijfvulling,  
blauw-, of zwartschrijvend

**BASIC**  
Glanzend opake kunststof houder

**METALLIC**  
Kunststof houder in metallic kleuren,  
metalen clip

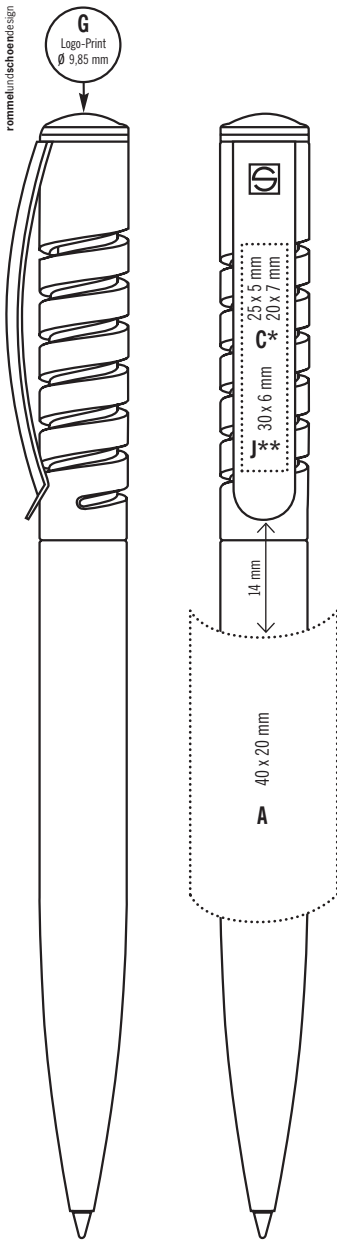

**NOMINEE**  
Designpreis der BFD  
Design Award of the FFDG



<b>A</b> SCREEN PRINT	<b>C</b> TAMPO PRINT
<b>G</b> LOGO PRINT	<b>J</b> LASER ENGRAVING

\* nur bei 2303  
\*\* nur bei 2310  
  
\* only on 2303  
\*\* only on 2310  
  
\* seulement sur 2303  
\*\* seulement sur 2310  
  
\* alleen bij 2303  
\*\* alleen bij 2310



**NEW**

**2303 BASIC**

Farben · Colours · Coloris · Kleuren

	white
	PMS 485 C
	PMS 288 C
	PMS 349 C



# NEW SPRING



SPECIAL FEATURE:



LOGO PRINT

## 2310 METALLIC

Farben · Colours · Coloris · Kleuren



D

**DUO PEN**

Drehkugelschreiber, schwarz  
Textmarkerspitze

**SOFT-SPRING**

Druckkugelschreiber  
Metallclip  
ergonomische Softgriffzone  
Metallisierte Spitze und Spiralfeder  
Qualitäts-Großraummine,  
blau oder schwarz

GB

**DUO PEN**

Twist-mechanism ballpen,  
black ink refill  
highlighter tip

**SOFT-SPRING**

Retractable ballpen  
Metal clip  
Ergonomic soft grip section  
Metallised tip and spiral spring  
Large capacity quality refill,  
blue or black

F

**DUO PEN**

Stylo à bille à mécanisme  
tournant, avec surligneur intégré

**SOFT-SPRING**

Stylo à bille rétractable,  
Clip en métal,  
Zone de préhension ergonomique  
souple, pointe et ressort métallisés,  
Recharge de qualité de grande capacité,  
bleue ou noire

NL

**DUO PEN**

Balpen met draaimechaniek,  
zwartschrijvend  
Tekstmarker

**SOFT-SPRING**

Balpen  
Metalen clip  
Ergonomische softgripzone  
Gemetalliseerd puntstuk en spiraalveer  
Kwaliteits-langschrijfvulling,  
blauw-, of zwartschrijvend

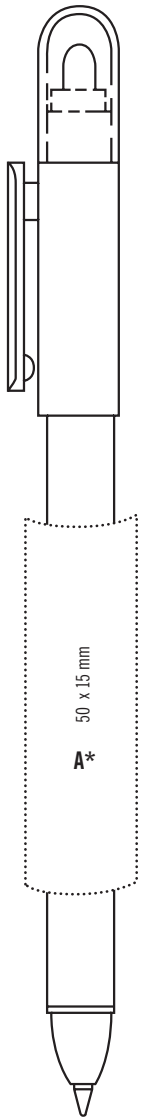

- \* nur 1-farbig
- \* 1 colour only
- \* 1 couleur seulement
- \* uitsluitend in 1 kleur



**2122 DUO PEN**

Farben · Colours · Coloris · Kleuren

I white

# DUO PEN

---

# SOFT SPRING

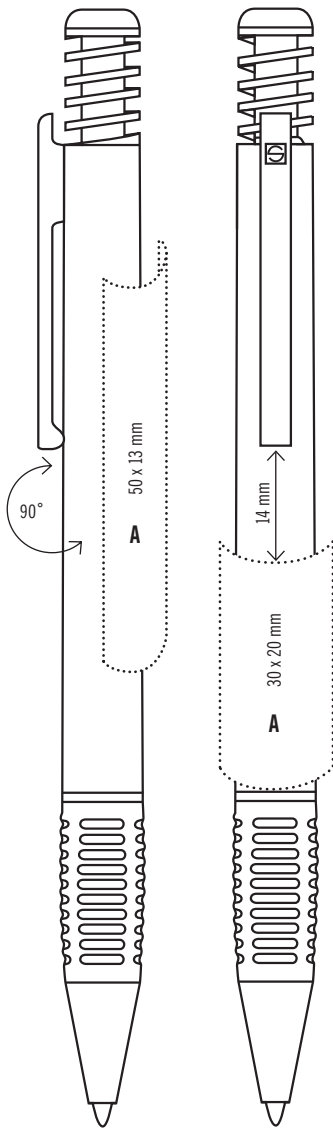

**A**  
SCREEN  
PRINT



## 2067 SOFT SPRING

Farben · Colours · Coloris · Kleuren



**D**

Druckkugelschreiber  
Gehäuse mit Anti-Roll-Effekt  
für effektive Werbedrucke  
Qualitäts-Großraummine,  
blau oder schwarz

**CLEAR**

glänzend transparentes Gehäuse

**XL CLEAR**

glänzend transparentes Gehäuse  
und Metallspitze

**GB**

Retractable ballpen  
Barrel with 'anti roll' effect for  
branding with impact  
Large capacity quality refill,  
blue or black

**CLEAR**

High gloss translucent barrel

**XL CLEAR**

High gloss translucent barrel  
and metal tip

**F**

Stylo à bille rétractable  
Corps à effet anti-basculement,  
Recharge de qualité de grande capacité,  
bleue ou noire

**CLEAR**

Corps translucide brillant

**XL CLEAR**

Corps translucide brillant et  
pointe en métal

**NL**

Balpen  
Houder met anti-rol-effect  
Kwaliteits-longschrijfvulling,  
blauw-, of zwartschrijvend

**CLEAR**

Glanzend transparante houder

**XL CLEAR**

Glanzend transparante houder  
en metalen punt

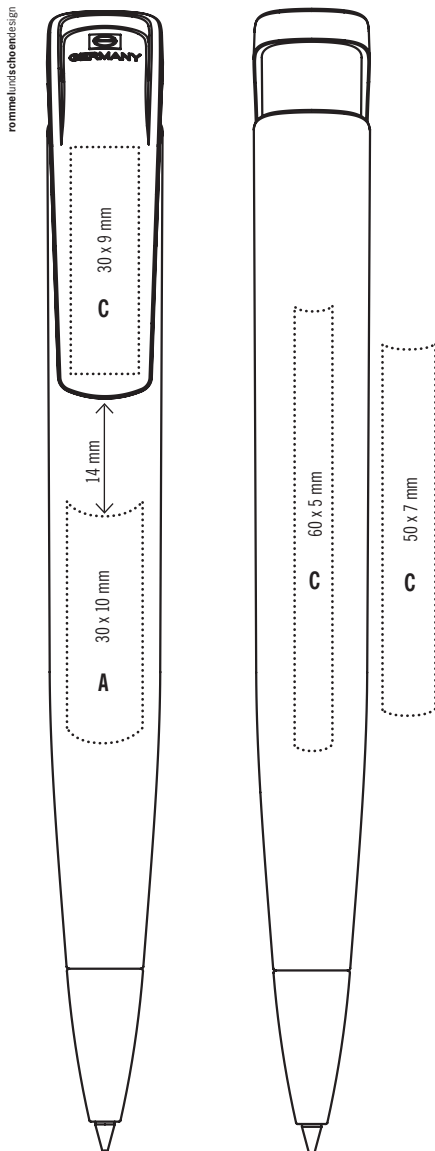
**2732 CLEAR**

Farben · Colours · Coloris · Kleuren



# SKEYE

## SPECIAL FEATURE:

- > Anti-Roll-Effekt für effektive Werbedrucke
- > für Werbung im Blickpunkt
- > 'anti roll' effect for barrel branding with impact
- > ensure your branding is always centre stage
- > effet anti-basculement
- > votre message reste toujours visible
- > Anti-rol-effect
- > Voor in het oog springende reclame



## 2733 XL CLEAR

Farben · Colours · Coloris · Kleuren



**D**

Druckkugelschreiber  
Gehäuse mit Anti-Roll-Effekt  
für effektive Werbedrucke  
Qualitäts-Großraummine,  
blau oder schwarz

**BASIC**

glänzend opakes Kunststoffgehäuse

**ICY**

matt transparentes Kunststoffgehäuse

**XL ALU**

matt metallisiertes Kunststoffgehäuse,  
Metallspitze

**GB**

Retractable ballpen  
Barrel with 'anti roll' effect for  
barrel branding with impact  
Large capacity quality refill,  
blue or black

**BASIC**

High gloss opaque plastic barrel

**ICY**

Matt translucent plastic barrel

**XL ALU**

Matt metallised barrel  
Metal tip

**F**

Stylo à bille rétractable,  
Corps à effet anti-basculement,  
Recharge de qualité de grande capacité,  
bleue ou noire

**BASIC**

Corps en plastique opaque brillant

**ICY**

Corps en plastique translucide brillant

**XL ALU**

Corps en plastique métallisé mat,  
Pointe en métal solide

**NL**

Balpen  
Houder met anti-rol-effect  
Kwaliteits-longschrijfvulling,  
blauw-, of zwartschrijvend

**BASIC**

Glanzend opake kunststof houder

**ICY**

Mat transparante kunststof houder

**XL ALU**

Mat gemetalliseerde kunststof houder,  
metalen punt

rommelincheschoemdesign

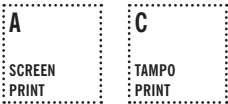
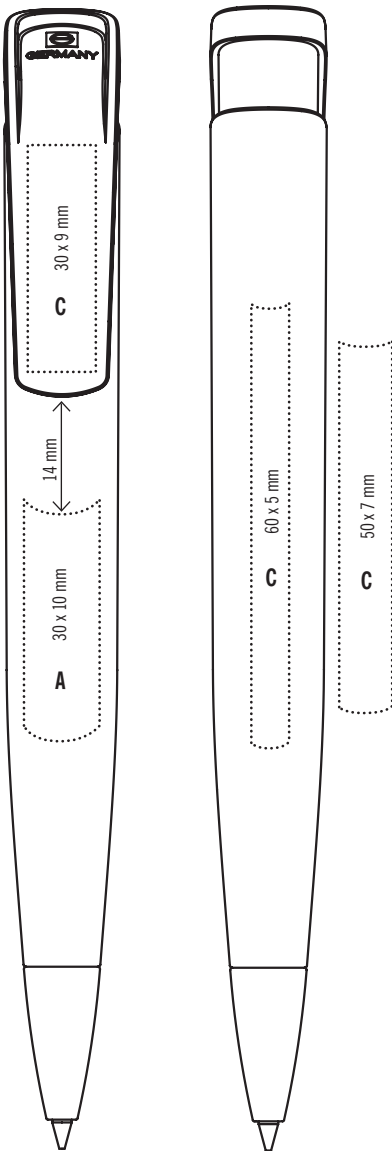
**2734 BASIC**

Farben · Colours · Coloris · Kleuren



# SKEYE



**NEW**



**NEW**



**NEW**

**SPECIAL FEATURE:**

- > *Anti-Roll-Effekt für effektive Werbedrucke*
- > *für Werbung im Blickpunkt*
- > *anti roll' effect for barrel branding with impact*
- > *ensure your branding is always centre stage*
- > *effet anti-basculement*
- > *votre message reste toujours visible*
- > *Anti-rol-effect*
- > *Voor in het oog springende reclame*



**NEW**

## 2736 ICY

Farben · Colours · Coloris · Kleuren



## 2739 XL ALU

Farben · Colours · Coloris · Kleuren



| PMS 877 C

**D**

Druckkugelschreiber  
das Original  
breite Softgriffzone  
Qualitätsmine,  
blau oder schwarz

**ICY**

Gehäuse aus gefroretetem  
transparenten Kunststoff

**COLOUR MIX PEN**

individuelle Farbkombinationen  
selbst zusammenstellen

**GB**

Retractable ballpen  
The original  
Broad soft grip  
Quality refill,  
blue or black

**ICY**

Frosted translucent plastic barrel

**COLOUR MIX PEN**

Create individual colour combinations

**F**

Stylo à bille rétractable,  
L'original  
Large zone de préhension souple,  
Recharge de qualité,  
bleue ou noire

**ICY**

Corps en plastique transparent givré

**COLOUR MIX PEN**

Faites votre propre combinaison  
de couleurs

**NL**

Balpen  
Het origineel!  
Brede Softgripzone  
Kwaliteitsvulling,  
blauw- of zwartschrijvend

**ICY**

Houder van frosty transparant kunststof

**COLOUR MIX PEN**

Individuele kleurcombinaties  
zelf samenstellen

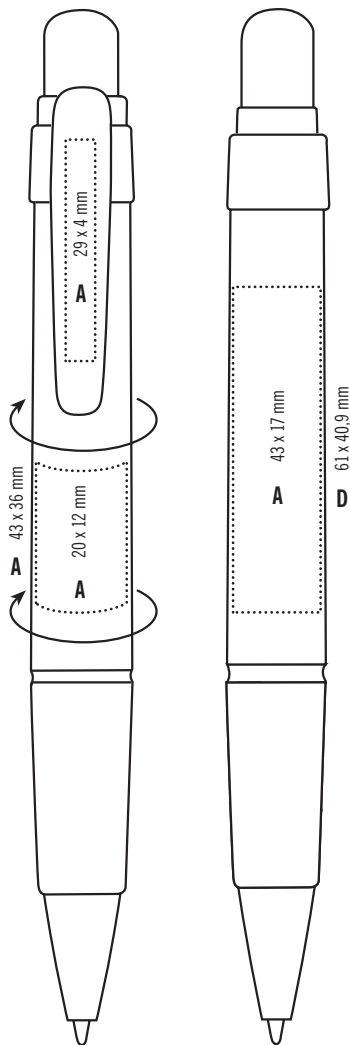
**1177 ICY**

Farben · Colours · Coloris · Kleuren



- PMS 313 C
- PMS 267 C
- PMS 1225 C
- PMS 201 C
- PMS 1505 C
- PMS 347 C
- PMS 286 C
- PMS 416 C
- icy



# BIG PEN

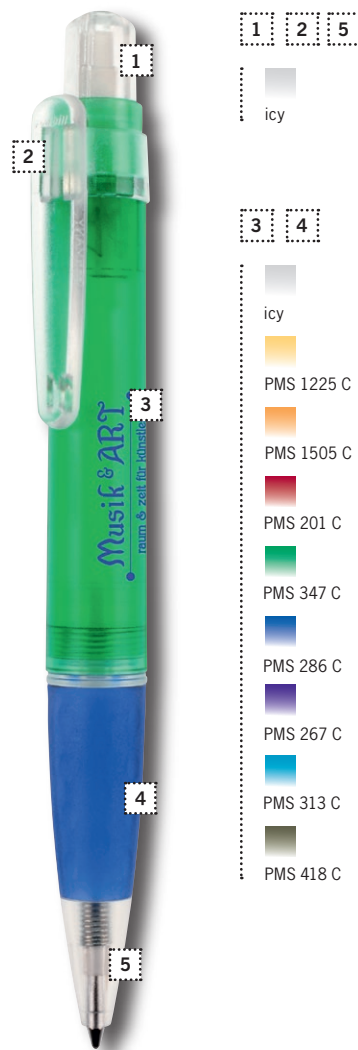

## 1177C COLOUR MIX PEN

Lieferbare Kombinationsfarben siehe Abbildung.

See illustration for available colour combinations.

Coloris de combinaison disponibles selon illustration.



## 1177 COLOUR MIX PEN

Leverbare kleuren volgens afbeelding.

D

Druckkugelschreiber  
das Original  
breite Softgriffzone  
Qualitätsmine,  
blau oder schwarz

**BIG PEN**

opakes Kunststoffgehäuse

**COLOUR MIX PEN**

individuelle Farbkombinationen  
selbst zusammenstellen

GB

Retractable ballpen  
The original  
Broad soft grip section  
Quality refill,  
blue or black

**BIG PEN**

Opaque plastic barrel

**COLOUR MIX PEN**

Create individual colour combinations

F

Stylo à bille rétractable,  
L'original,  
Large zone de préhension souple,  
Recharge de qualité,  
bleue ou noire

**BIG PEN**

Corps en plastique opaque

**COLOUR MIX PEN**

Faites votre propre combinaison  
de couleurs

NL

Balpen  
Het origineel!  
Brede Softgripzone  
Kwaliteitsvulling,  
blauw- of zwartschrijvend

**BIG PEN**

Opaque kunststof houder

**COLOUR MIX PEN**

Individuele kleurcombinaties  
zelf samenstellen

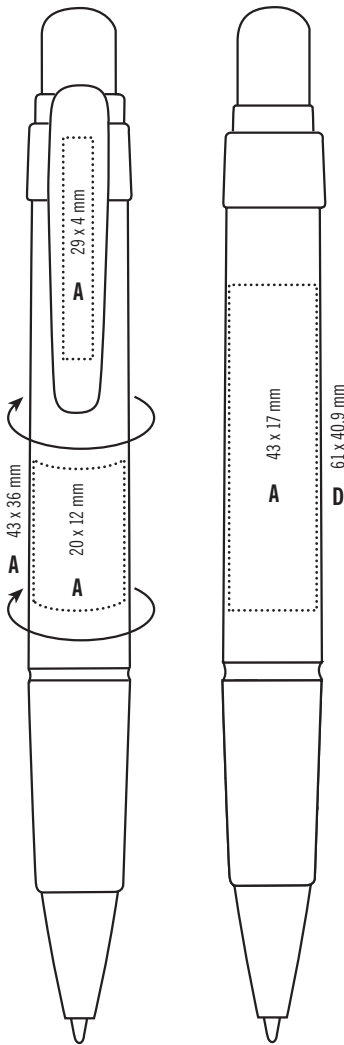

**1133 BIG PEN**

Farben · Colours · Coloris · Kleuren

-  PMS 429 C
-  black
-  PMS 116 C
-  PMS 485 C
-  PMS 349 C
-  PMS 2935 C
-  PMS 123 C / black
-  PMS 485 C / black
-  PMS 2935 C / black
-  PMS 349 C / black
-  black / black

# BIG PEN



## 1133 COLOUR MIX PEN

Lieferbare Kombinationsfarben siehe Abbildung.

See illustration for available colour combinations.

Coloris de combinaison disponibles selon illustration.

Leverbare kleuren volgens afbeelding.

## 1133 COLOUR MIX PEN

D

Druckkugelschreiber  
das Original  
6-zeiliger Werbedruck unter zwei  
Sichtfenstern  
Qualitätsmine,  
blau oder schwarz

**BIG MESSAGE PEN**

individuelle Farbkombinationen  
selbst zusammenstellen

GB

Retractable message ballpen  
The original  
6 lines of rotating text  
2 viewing windows  
Quality refill,  
blue or black

**BIG MESSAGE PEN**

create individual colour combinations

F

Stylo à bille rétractable,  
L'original,  
6 lignes de texte sous deux fenêtres,  
Recharge de qualité,  
bleue ou noire

**BIG MESSAGE PEN**

Faites votre propre combinaison  
de couleurs

NL

Balpen  
Het origineel!  
6 Regels roterende reclame  
met twee vensters  
Kwaliteitsvulling,  
blauw- of zwartschrijvend

**BIG MESSAGE PEN**

Individuele kleurcombinaties  
zelf samenstellen

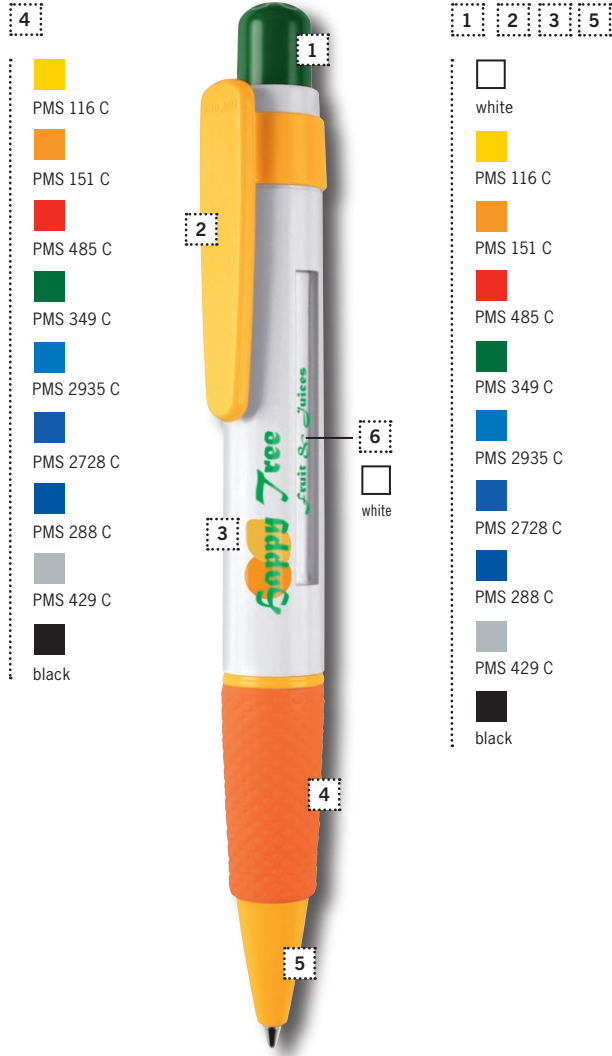
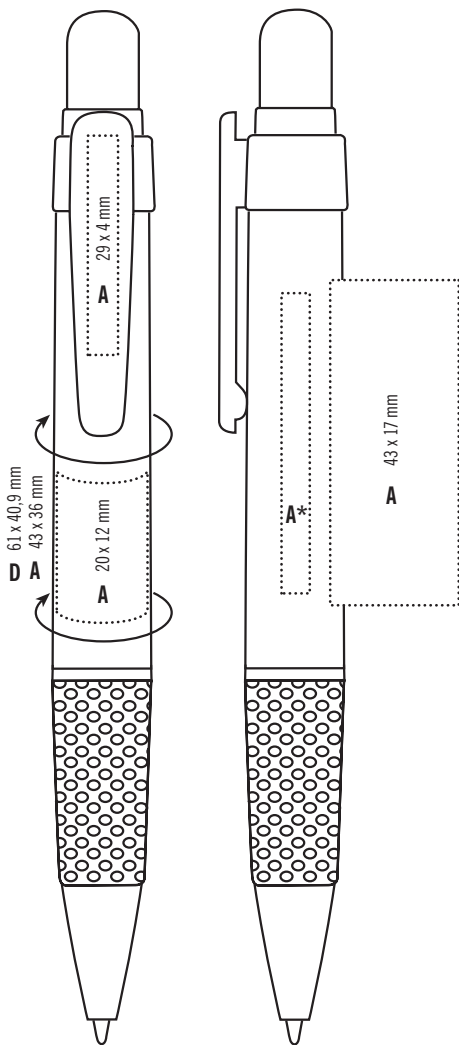

**A**  
SCREEN  
PRINT

**D**  
360°  
PRINT

- \* 6 Zeilen
- \* 6 lines
- \* 6 lignes
- \* 6 tektsregels

COLOUR MIX  
PEN

**1171C BIG MESSAGE PEN**

Lieferbare Kombinations-  
farben siehe Abbildung.

See illustration for available  
colour combinations.

Coloris de combinaison  
disponibles selon  
illustration.

Leverbare kleuren volgens  
afbeelding.

# BIG PEN

## SPECIAL FEATURE:

- > 6 Zeilen rotierender Werbedruck
- > unter 2 Fenstern
- > die perfekte Visitenkarte
- > 6 lines of rotating text
- > 2 viewing windows
- > the perfect business card
- > 6 lignes
- > publicité rotative
- > sous deux fenêtres
- > 6 Tekstregels
- > roterende reclame
- > Met 2 vensters
- > Het perfecte visitekaartje



1171C BIG MESSAGE PEN

**D**

Druckkugelschreiber  
ergonomische Softgriffzone  
Qualitäts-Großraummine,  
blau oder schwarz

**METAL**

Metallclip

**METAL CLEAR**

transparentes Kunststoffgehäuse,  
Metallclip

**SOFT CLEAR**

transparentes Kunststoffgehäuse

**GB**

Retractable ballpen,  
Ergonomic soft grip section  
Large capacity quality refill,  
blue or black

**METAL**

White opaque barrel with metal clip

**METAL CLEAR**

Translucent plastic barrel  
Metal clip

**SOFT CLEAR**

Translucent plastic barrel

**F**

Stylo à bille rétractable,  
Zone de préhension ergonomique  
souple,  
Recharge de qualité de grande capacité,  
bleue ou noire

**METAL**

Clip en métal

**METAL CLEAR**

Corps translucide, clip en métal

**SOFT CLEAR**

Corps translucide brillant

**NL**

Balpen  
Ergonomische softgripzone  
Kwaliteits-langschrijfvulling,  
blauw-, of zwartschrijvend

**METAL**

Metalen clip

**METAL CLEAR**

Transparante kunststofhouder,  
metalen clip

**SOFT CLEAR**

Transparante kunststofhouder

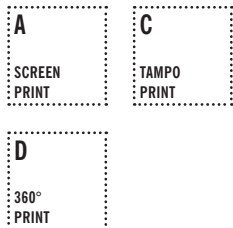
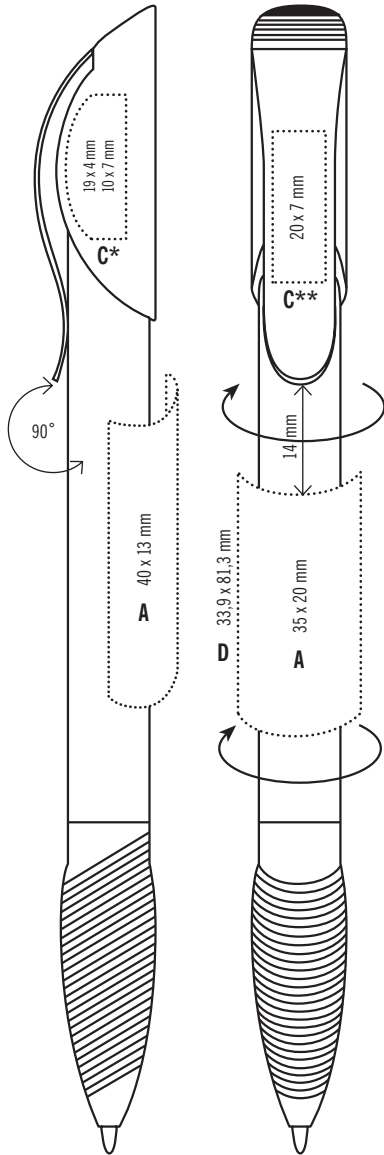

\* nur 1-farbig  
\*\* nur bei 2339

\* only 1 colour  
\*\* only on 2339

\* seulement 1 couleur  
\*\* seulement sur 2339

\* uitsluitend in 1 kleur  
\*\* alleen bij 2339

**2179 METAL**

Farben · Colours · Coloris · Kleuren



PMS 116 C

PMS 151 C

PMS 485 C

PMS 288 C

PMS 349 C

PMS 429 C

# HATTRIX



## 2419 METAL CLEAR

Farben · Colours · Coloris · Kleuren

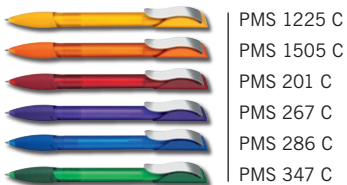

## 2339 SOFT CLEAR

Farben · Colours · Coloris · Kleuren



D

Druckkugelschreiber  
Qualitätsmine,  
blau oder schwarz

**COLOUR MIX PEN**

individuelle Farbkombinationen  
selbst zusammenstellen

**BASIC**

profilieretes Kunststoffvorderteil

**SOFT**

ergonomische Softgriffzone

GB

Retractable ballpen  
Quality refill,  
blue or black

**COLOUR MIX PEN**

create individual colour combinations

**BASIC**

Rippled grip section

**SOFT**

Ergonomic soft grip section

F

Stylo à bille rétractable,  
Recharge de qualité,  
bleue ou noire

**COLOUR MIX PEN**

Faites votre propre combinaison  
de couleurs

**BASIC**

Zone de préhension profilée

**SOFT**

Zone de préhension ergonomique  
souple

NL

Balpen  
Kwaliteitsvulling,  
blauw-, of zwartschrijvend

**COLOUR MIX PEN**

Individuele kleurcombinaties  
zelf samenstellen

**BASIC**

Geprofileerde gripzone

**SOFT**

Ergonomische softgripzone

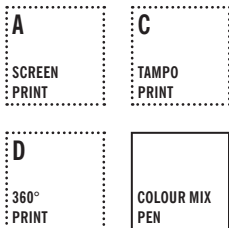
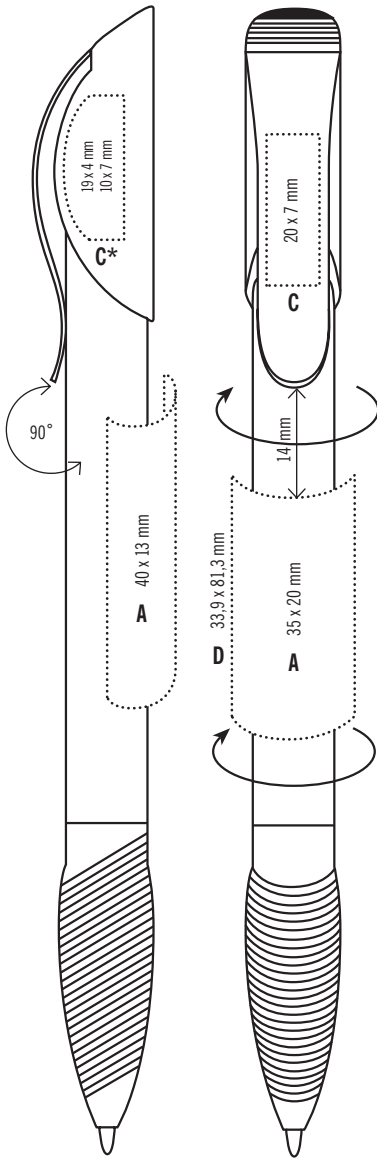

\* nur 1-farbig

\* 1 colour only

\* 1 couleur  
seulement

\* uitsluitend in  
1 kleur

**2156 COLOUR MIX PEN**

Lieferbare Kombinations-  
farben siehe Abbildung.

See illustration for available  
colour combinations.

Coloris de combinaison  
disponibles selon  
illustration.

Leverbare kleuren volgens  
afbeelding.

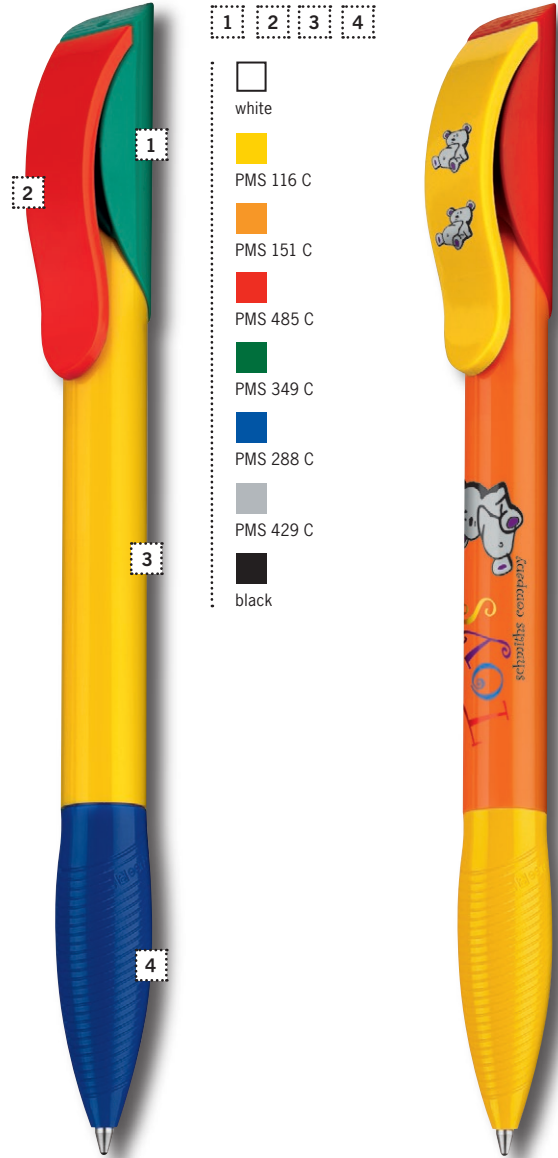



# HATTRIX



## 2177 BASIC

Farben · Colours · Coloris · Kleuren



## 2178 SOFT

Farben · Colours · Coloris · Kleuren

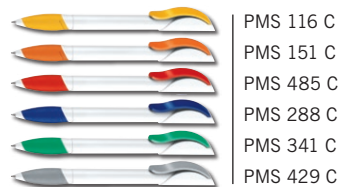

D

Druckkugelschreiber mit einzigartiger, dauerhaft antibakterieller Wirkung  
Qualitätsmine, blau oder schwarz

**Einzigartig:** auch der Druck ist antibakteriell

www.antibacpen.com

GB

Certified Superbug Killer  
Retractable antibacterial pen with a unique, permanent antibacterial effect  
Quality refill, blue or black

**Unique pen:** with the added benefit of antibacterial branding

www.antibacpen.com

F

Stylo à bille rétractable avec un procédé anti-bactérien unique.  
Recharge de qualité, bleue ou noire.

**Procédé unique :** L'encre d'impression est également anti-bactérienne.

www.antibacpen.com

NL

Balpen met unieke, duurzaam antibacteriële eigenschappen  
Kwaliteitsvulling, blauw- of zwartschrijvend

**Uniek:** ook de bedrukking is antibacterieel

www.antibacpen.com

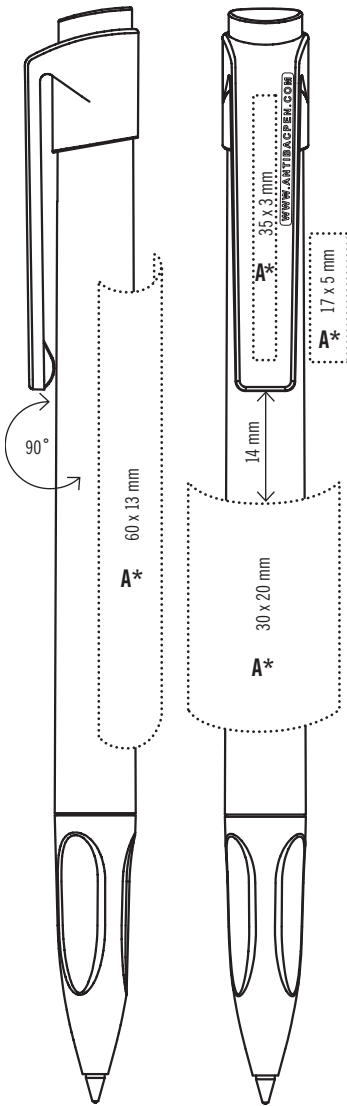

SPECIAL FEATURE:



A  
SCREEN  
PRINT

- \* antibakterieller Druck
- \* antibacterial branding
- \* impression anti-bactérienne
- \* antibacteriële bedrukking



NEW

2645 ANTIBAC

Farben · Colours · Coloris · Kleuren

I white

# ANTIBAC

## SPECIAL FEATURE:

- > *einzigartige, dauerhaft antibakterielle Wirkung*
- > *Wirkt gegen Bakterien, Viren und Pilze*
- > *Certified Superbug Killer*
- > *Kills 99.9% of harmful bacteria and viruses*
- > *Effet antibactérien unique car l'agent actif est incorporé au coeur du plastique.*
- > *Supprime les bactéries et des virus les plus virulents.*
- > *unieke, duurzaam antibacteriële eigenschappen*
- > *werkzaam tegen bacteriën, virussen en schimmels*

*C.Difficile, MRSA  
Listeria monocytogenes,  
Salmonella enteritidis,  
Escherichia coli, Bacillus cereus,  
Aspergillus niger,  
Pseudomonas aeruginosa,  
Klebsiella pneumoniae,  
Saccarmycescervisiae,  
Penicillium purpurogenum*

## WIRKSTOFF

Anerkannt von der FDA (U.S. Food & Drug Administration), der BPD (E. U. Bionocide Product Directive) und der HSE (UK Health & Safety Executive).

Wirkung vom FDAS (Food & Drug Analytical Service Ltd.) getestet und nach BS EN 20645 zertifiziert.

Positiv getestet nach EN 71/3 und EN 71/9.

## ACTIVE AGENT

Approved by the FDA (U.S. Food & Drug Administration), the BPD (E. U. Bionocide Product Directive) and the HSE (UK Health & Safety Executive).

Effect tested by FDAS (Food & Drug Analytical Service Ltd.) and certified according to BS EN 20645.

Tested positive to EN 71/3 and EN 71/9.

## SUBSTANCE ANTIBACTERIENNE

Elle est approuvée par la FDA (U.S. Food & Drug Administration), le BPD (E. U. Bionocide Product Directive) et le HSE (UK Health & Safety Executive).

Tests effectués par la FDAS (Food & Drug Analytical Service Ltd.) et certifiés en accord avec BS EN 20645.

Test positif selon EN 71/3 et EN 71/9

## WERKZAAM BESTANDDEEL

Erkend door de FDA (U. S. Food & Drug Administration), de BPD (E. U. Bionocide Product Directive) en de HSE (UK Health Safety Executive).

Werking door de FDAS (Food & Drug Analytical Service Ltd.) getest en volgens BS EN 20645 gecertificeerd.

Positief getest volgens EN 71/3 en EN 71/9.



D

Druckkugelschreiber  
hochwertige Metallspitze  
Qualitäts-Großraummine,  
blau oder schwarz

**XL CLEAR**

glänzend transparentes Gehäuse

**XL METALLIC**

metalllicfarbenes Gehäuse

GB

Retractable ballpen,  
High-quality metal tip  
Large capacity quality refill  
blue or black

**XL CLEAR**

High gloss transparent barrel

**XL METALLIC**

Metallic coloured barrel

F

Stylo à bille rétractable,  
Pointe en métal,  
Recharge de qualité de grande capacité,  
bleue ou noire

**XL CLEAR**

Corps translucide brillant

**XL METALLIC**

Corps de couleur métallisée

NL

Balpen  
Hoogwaardig  
metalen punt  
Kwaliteits-langschrijfvulling,  
blauw-, of zwartschrijvend

**XL CLEAR**

Glanzend transparante houder





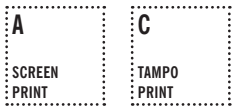
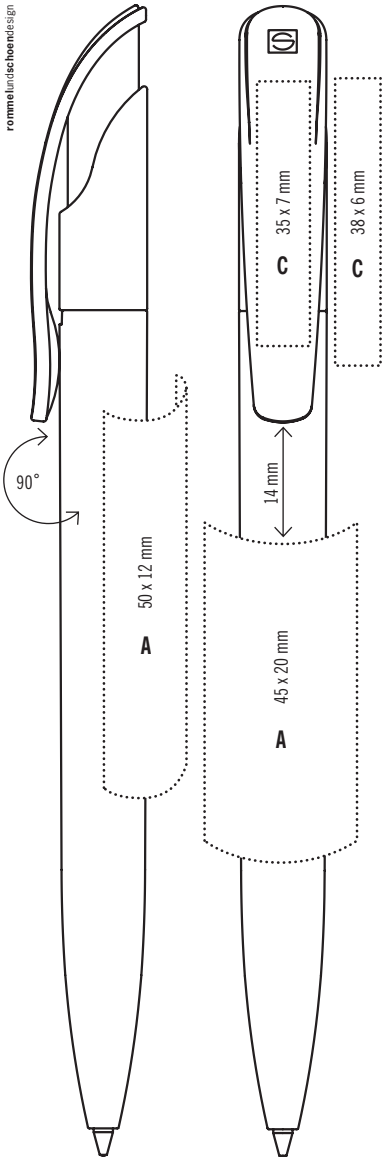



**XL METALLIC**

Houder in metallic look



**2925 XL CLEAR**

Farben · Colours · Coloris · Kleuren

-  clear
-  PMS 1225 C
-  PMS 267 C
-  PMS 1505 C
-  PMS 201 C
-  PMS 3425 C
-  PMS 281 C
-  PMS 418 C

# CHALLENGER



**2926 XL METALLIC**

Farben · Colours · Coloris · Kleuren

-  white
-  PMS 1817 C
-  PMS 3305 C
-  PMS 648 C
-  PMS 432 C
-  black

**D**

Druckkugelschreiber  
ergonomische Softgriffzone

**SOFT**

opakes Gehäuse  
Qualitätsmine,  
blau oder schwarz

**SOFT CLEAR**

glänzend transparentes Gehäuse  
Qualitäts-Großraummine,  
blau oder schwarz

**GB**

Retractable ballpen  
Ergonomic soft grip section

**SOFT**

Opaque barrel  
Quality refill,  
blue or black

**SOFT CLEAR**

Glossy translucent barrel  
Large capacity quality refill,  
blue or black

**F**

Stylo à bille rétractable,  
Zone de préhension  
ergonomique souple

**SOFT**

Corps opaque,  
Recharge de qualité,  
bleue ou noire

**SOFT CLEAR**

Corps translucide brillant,  
Recharge de qualité de grande capacité,  
bleue ou noire

**NL**

Balpen  
Ergonomische softgripzone

**SOFT**

Opake houder  
Kwaliteitsvulling, blauw-,  
of zwartschrijvend

**SOFT CLEAR**

Glanzend transparante houder  
Kwaliteits-langschrijfvulling,  
blauw-, of zwartschrijvend

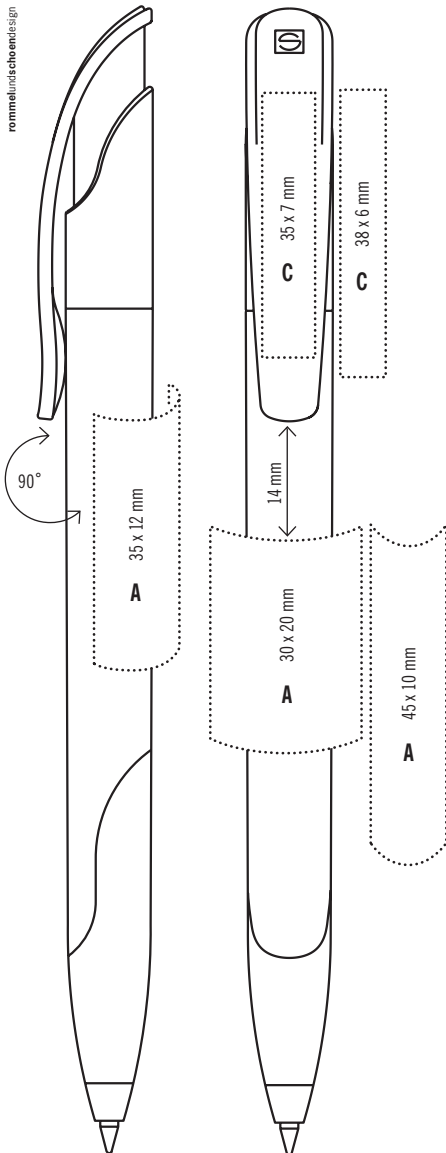
**2417 SOFT**

Farben · Colours · Coloris · Kleuren



# CHALLENGER



## 2597 SOFT CLEAR

Farben · Colours · Coloris · Kleuren



D

Druckkugelschreiber  
Qualitäts-Großraummine,  
blau oder schwarz

**COLOUR MIX PEN**

individuelle Farbkombinationen  
selbst zusammenstellen

**ICY**

Gehäuse und Clip matt transparent

GB

Retractable ballpen  
Large capacity quality refill,  
blue or black

**COLOUR MIX PEN**

Create individual colour combinations

**ICY**

Matt translucent barrel and clip

F

Stylo à bille rétractable,  
Recharge de qualité de grande capacité,  
bleue ou noire

**COLOUR MIX PEN**

Faites votre propre combinaison  
de couleurs

**ICY**

Corps et clip translucides mats

NL

Balpen  
Kwaliteits-langschrijfvulling,  
blauw-, of zwartschrijvend

**COLOUR MIX PEN**

Individuele kleurcombinaties  
zelf samenstellen

**ICY**

Mat transparante houder en clip

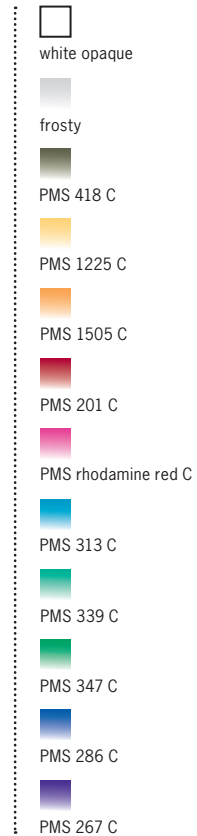
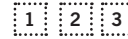
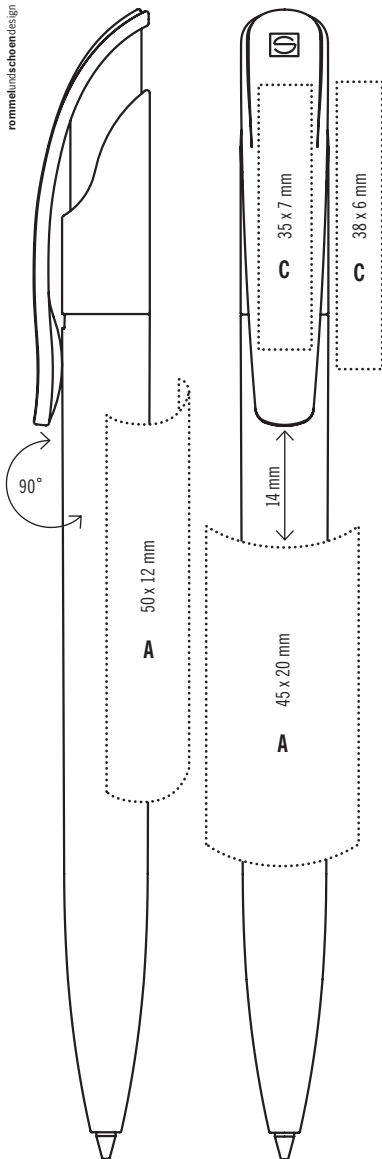

**2474 COLOUR MIX PEN**

Lieferbare Kombinations-  
farben siehe Abbildung.

See illustration for available  
colour combinations.

Coloris de combinaison  
disponibles selon illu-  
stration.

Leverbare kleuren volgens  
afbeelding.



# CHALLENGER



2474 COLOUR MIX PEN



2418 ICY

Farben · Colours · Coloris · Kleuren



D

Druckkugelschreiber

**BASIC**  
opakes Kunststoffgehäuse  
Qualitätsmine,  
blau oder schwarz

**ALU**  
matt metallisiertes Gehäuse  
transparenter Kunststoffclip  
Qualitäts-Großraummine,  
blau oder schwarz

GB

Retractable ballpen

**BASIC**  
Opaque plastic barrel  
Quality refill,  
blue or black

**ALU**  
Matt metallised barrel  
Translucent plastic clip  
Large capacity quality refill,  
blue or black

F

Stylo à bille rétractable

**BASIC**  
Corps opaque,  
Recharge de qualité,  
bleue ou noire

**ALU**  
Corps de couleur métallisé mat,  
Large clip translucide,  
Recharge de qualité de grande capacité,  
bleue et noire

NL

Balpen

**BASIC**  
Opake kunststof houder  
Kwaliteitsvulling, blauw-,  
of zwartschrijvend

**ALU**  
Houder met metallic laklaag  
Transparante kunststofclip  
Kwaliteits-langschrijfvulling,  
blauw-, of zwartschrijvend

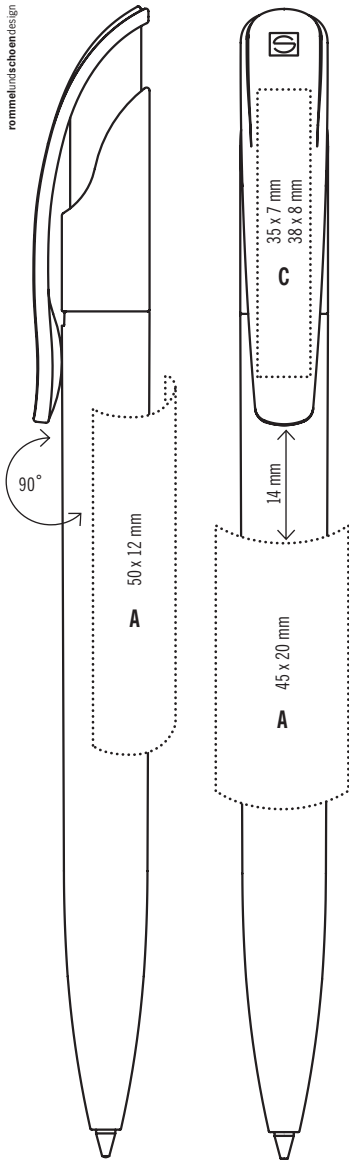

**2416 BASIC**

Farben · Colours · Coloris · Kleuren

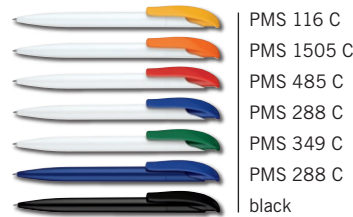

# CHALLENGER



2416 BASIC



2519 ALU

Farben · Colours · Coloris · Kleuren



D

Druckkugelschreiber  
breiter Kunststoffclip  
große Softgriffzone  
Qualitätsmine,  
blau oder schwarz

ICY

matt transparentes Gehäuse

COLOUR MIX PEN

individuelle Farbkombinationen  
selbst zusammenstellen

GB

Retractable ballpen  
Broad plastic clip  
Large soft grip section  
Quality refill,  
blue or black

ICY

Matt translucent barrel

COLOUR MIX PEN

Create individual colour  
combinations

F

Stylo à bille rétractable,  
Large clip en plastique,  
Large zone profilée,  
Recharge de qualité,  
bleue ou noire

ICY

Corps translucide mat

COLOUR MIX PEN

Faites votre propre  
combinaison de couleurs

NL

Balpen  
Brede kunststofclip  
Grote Softgripzone  
Kwaliteitsvulling,  
blauw-, of zwartschrijvend

ICY

Mat transparante houder

COLOUR MIX PEN

Individuele kleurcombinaties  
zelf samenstellen

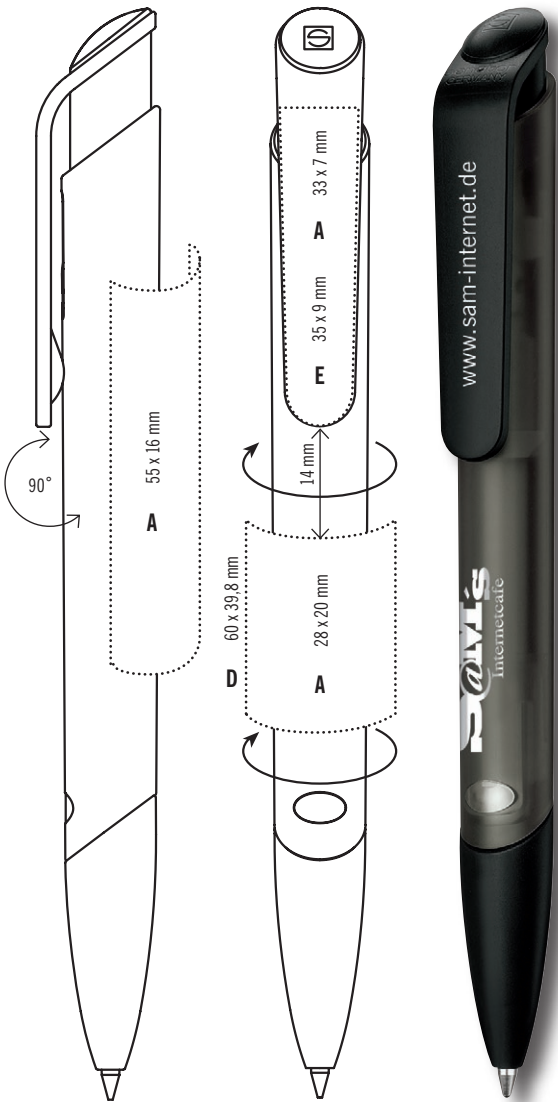

<b>A</b> SCREEN PRINT	<b>D</b> 360° PRINT
<b>E</b> DIGITAL PRINT	<b>P</b> CLIP 4U FEATURE

COLOUR MIX  
PEN

GEL  
OPTION

2760 ICY

Farben · Colours · Coloris · Kleuren

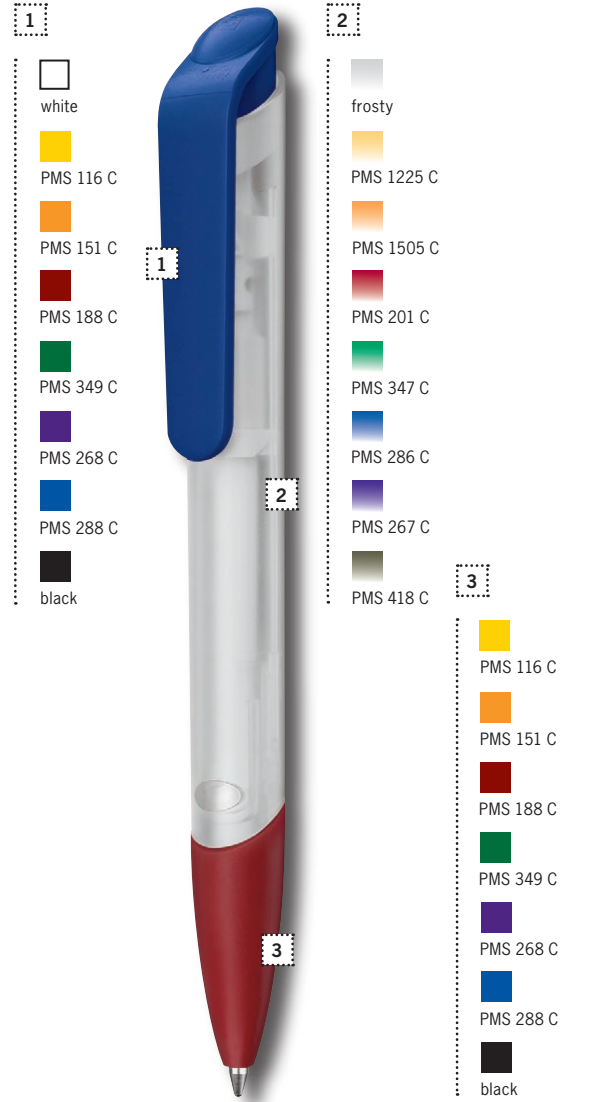

2766 COLOUR MIX PEN

Lieferbare  
Kombinations-  
farben siehe  
Abbildung.

Available colour  
combinations see  
illustration.

Coloris de  
combinaison  
disponibles  
selon illustration.

Leverbare  
kleuren volgens  
afbeelding.

# AKZENTO



## 2763 ICY Clip 4U Service

CLIP: Erhabene oder vertiefte reliefartige Darstellung von Logos, Schriftzügen oder Mustern auf der kompletten Fläche des Clips.

INDIVIDUAL: Vollkommen individuelle Darstellung Ihres Motivs auf der kompletten Fläche des Clips.

CLIP: On the complete surface of the clip, logos, slogans or even patterns can be embossed or debossed.

INDIVIDUAL: The clip can be produced in the individual shape of the logo or product

CLIP : Sur toute la zone du clip, des logos d'entreprise, des inscriptions ou des dessins peuvent être estampés afin de présenter durablement la marque.

INDIVIDUAL : Le clip peut être entièrement personnalisé dans la forme du logo de l'entreprise ou d'un produit.

CLIP: Het gehele vlak van de clip kan aan uw Corporate Design aangepast worden. Binnen dit formaat kunnen logo's en reclame-slogans omgezet worden.

INDIVIDUAL: De clip kan volledig in de vorm van een logo of een product gemaakt worden.

- \* auf Anfrage
- \* on request
- \* sur demande
- \* op aanvraag

**D**

Druckkugelschreiber  
breiter Kunststoffclip  
Kunststoffspitze mit Profilrillen  
Qualitätsmine,  
blau oder schwarz

**BASIC**  
opakes Gehäuse

**ICC**  
individuelle PMS-Farben

**GB**

Retractable ballpen  
Large plastic clip  
Plastic tip with profile lines  
Quality refill,  
blue or black

**BASIC**  
Opaque barrel

**ICC**  
individual pantone colours

**F**

Stylo à bille rétractable,  
Large clip en plastique,  
Partie avant en plastique  
avec zone profilée,  
Recharge de qualité,  
bleue ou noire

**BASIC**  
Corps opaque

**ICC**  
Couleurs PMS individuelles

**NL**

Balpen  
Brede kunststofclip  
Kunststof geprofileerde punt  
Kwaliteitsvulling,  
blauw-, of zwartschrijvend

**BASIC**  
opake houder

**ICC**  
individuele PMS-kleuren

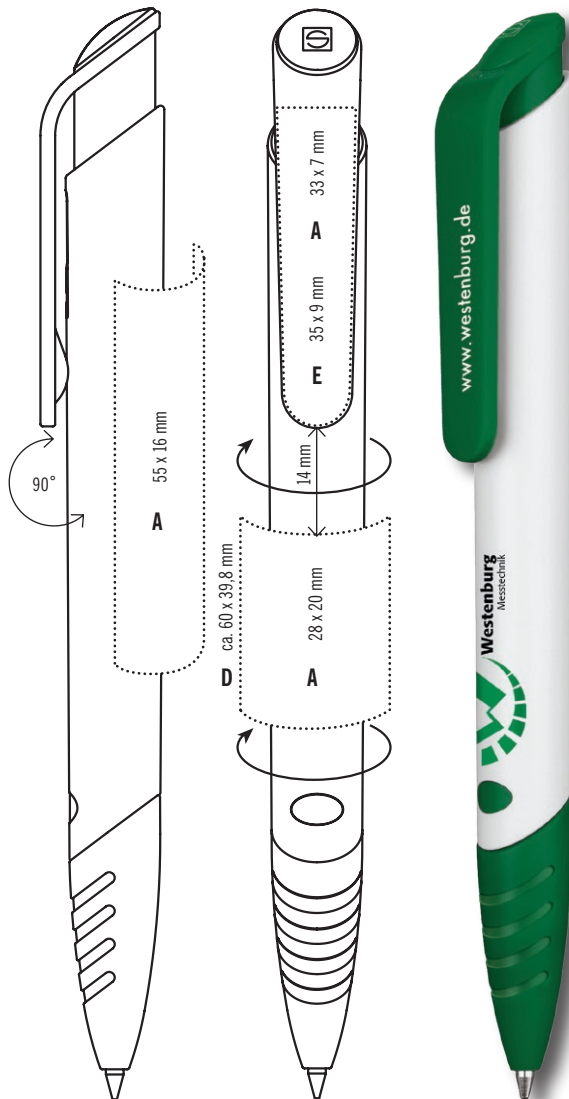

<b>A</b> SCREEN PRINT	<b>D</b> 360° PRINT
<b>E</b> DIGITAL PRINT	<b>P</b> CLIP 4U FEATURE

**2762 BASIC**

Farben · Colours · Coloris · Kleuren



**ICC INDIVIDUAL COLOUR CONCEPT**

Individuelle opake Kunststofffarben bereits ab 5.000 Stück in PMS-Farbe realisierbar.

Individual opaque plastic colours available in PMS shades from only 5,000 pcs. Injection à la couleur Pantone souhaitée dès 5000 pièces.

Individuele opake kunststofkleuren, al vanaf 5.000 stuks in eigen PMS-kleur te realiseren.



# AKZENTO



## 2764 BASIC Clip 4U Service

CLIP: Erhabene oder vertiefte reliefartige Darstellung von Logos, Schriftzügen oder Mustern auf der kompletten Fläche des Clips.

INDIVIDUAL: Vollkommen individuelle Darstellung Ihres Motivs auf der kompletten Fläche des Clips.

CLIP: On the complete surface of the clip, logos, slogans or even patterns can be embossed or debossed.

INDIVIDUAL: The clip can be produced in the individual shape of the logo or of a product.

CLIP : Sur toute la zone du clip, des logos d'entreprise, des inscriptions ou des dessins peuvent être estampés afin de présenter durablement la marque.

INDIVIDUAL : Le clip peut être entièrement personnalisé dans la forme du logo de l'entreprise ou d'un produit.

CLIP: Het gehele vlak van de clip kan aan uw Corporate Design aangepast worden. Binnen dit formaat kunnen logo's en reclame-slogans omgezet worden.

INDIVIDUAL: De clip kan volledig in de vorm van een logo of een product gemaakt worden.

**D**

Druckkugelschreiber  
Metalldrücker mit farbigem  
Kunststoffdekor

**METAL**

Gehäuseoberteil aus massivem Metall  
Qualitäts-Metall-Großraummine,  
blau

**BASIC**

Kunststoffmine,  
blau oder schwarz

**PLUS**

Qualitäts-Großraummine,  
blau oder schwarz

**GB**

Retractable ballpen  
Metal push button with  
coloured plastic decor

**METAL**

Solid metal upper part  
Large capacity metal quality refill,  
blue

**BASIC**

Plastic refill, blue or black

**PLUS**

Large capacity quality refill,  
blue or black

**F**

Stylo à bille rétractable  
Poussoir en métal avec point  
en matière plastique

**METAL**

Corps supérieure et attributs  
en métal solide,  
Recharge de qualité de grande capacité,  
bleue

**BASIC**

Recharge de qualité, bleue ou noire

**PLUS**

Recharge de qualité de grande capacité,  
bleue ou noire

**NL**

Balpen  
Metalen drukker met kunststof  
accent in de kleur van de houder

**METAL**

Bovenstuk van massief metaal  
Metalen kwaliteitsvulling  
(langschriftvulling),  
blauw-schrijvend

**BASIC**

Kwaliteitsvulling,  
blauw-, of zwartschrijvend

**PLUS**

Kwaliteits-longschriftvulling,  
blauw-, of zwartschrijvend

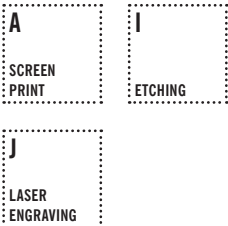
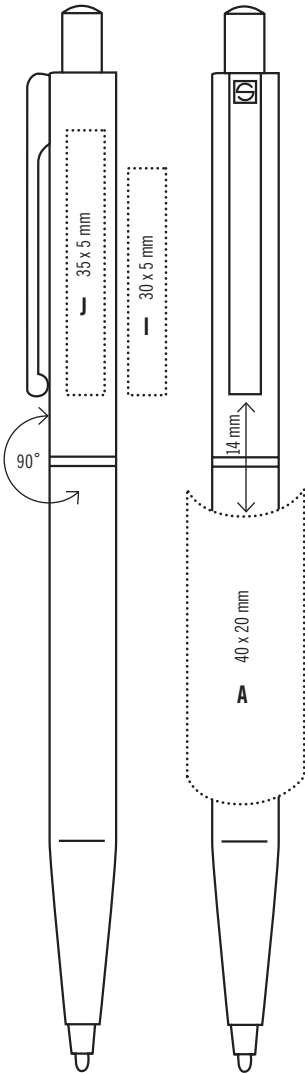
**2866 METAL**

Farben · Colours · Coloris · Kleuren



PMS 188 C

PMS 281 C

PMS 3435 C

black

white



# POINT

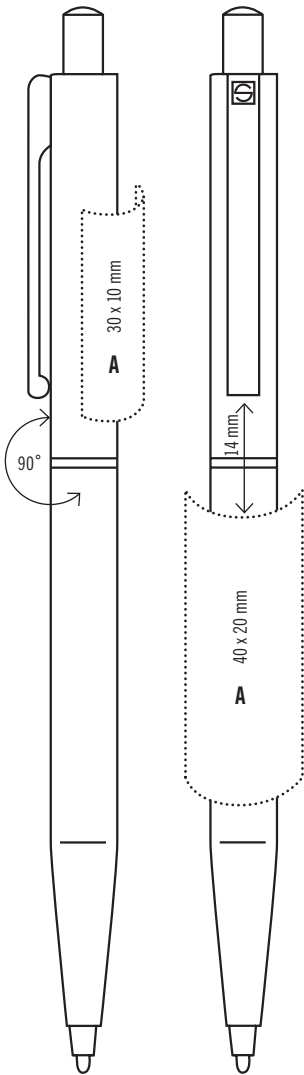

**A**  
SCREEN  
PRINT



## 2362 BASIC

Farben · Colours · Coloris · Kleuren



## 2590 PLUS

Farben · Colours · Coloris · Kleuren



**D**

Druckkugelschreiber  
Mit SENATOR typischen  
Profilrillen am Drücker.  
Softgriffzone  
Qualitätsmine,  
blau oder schwarz

**BASIC**  
opakes Gehäuse

**CLEAR**  
transparentes Gehäuse

**GB**

Retractable ballpen  
The original SENATOR push-clip  
Tactile soft grip section with dynamic  
deco rings  
Quality refill,  
blue or black

**BASIC**  
Opaque barrel

**CLEAR**  
Translucent barrel

**F**

Stylo à bille rétractable,  
Poussoir profilé de manière SENATOR,  
Zone de préhension souple,  
Recharge de qualité,  
bleue ou noire

**BASIC**  
Corps opaque

**CLEAR**  
Corps transparent

**NL**

Balpen  
Met typerende SENATOR-ribbels  
onder het drukmechaniek  
Softgripzone  
Kwaliteitsvulling,  
blauw-, of zwartschrijvend

**BASIC**  
Opake houder

**CLEAR**  
Transparente houder

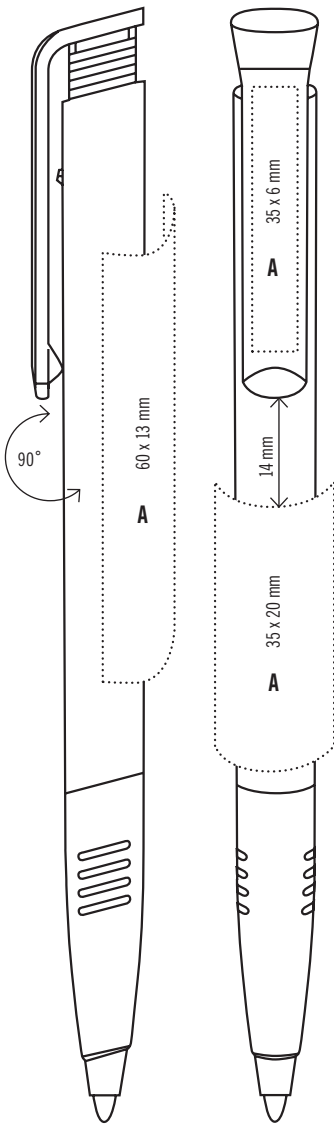
**2274 BASIC**

Farben · Colours · Coloris · Kleuren



PMS 116 C  
PMS 485 C  
PMS 288 C  
PMS 341 C  
white / black  
black

# SUPER-SOFT



## 2234 CLEAR

Farben · Colours · Coloris · Kleuren

	PMS 1225 C
	PMS 1505 C
	PMS 201 C
	PMS 347 C
	PMS 286 C
	PMS 267 C

**D**

Druckkugelschreiber  
Mit SENATOR typischen  
Profilrillen am Drücker  
Qualitätsmine,  
blau oder schwarz

**COLOUR MIX PEN**

individuelle Farbkombinationen  
selbst zusammenstellen

**ICY**

matt transparentes Gehäuse  
opaker Clip

**BASIC**

opakes Gehäuse

**GB**

Retractable ballpen,  
The original SENATOR push-button  
Quality refill,  
blue or black

**COLOUR MIX PEN**

Create individual colour combinations

**ICY**

Matt translucent barrel and  
opaque clip

**BASIC**

High gloss opaque barrel

**F**

Stylo à bille rétractable,  
Poussoir profilé de manière SENATOR,  
Recharge de qualité,  
bleue ou noire

**COLOUR MIX PEN**

Faites votre propre combinaison  
de couleurs

**ICY**

Corps translucide mat et clip opaquee

**BASIC**

Corps opaque

**NL**

Balpen  
Met typerende SENATOR-ribbels  
onder het drukmechaniek  
Kwaliteitsvulling,  
blauw-, of zwartschrijvend

**COLOUR MIX PEN**

Individuele kleurcombinaties  
zelf samenstellen

**ICY**

Mat transparante houder en opake clip

**BASIC**

Opake houder

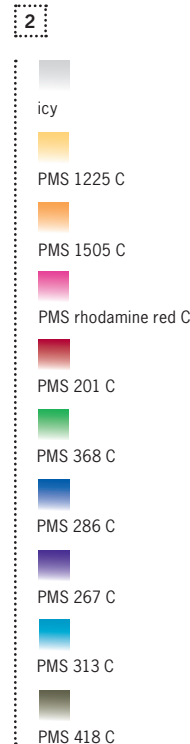
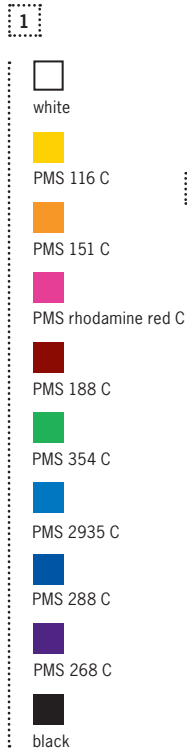
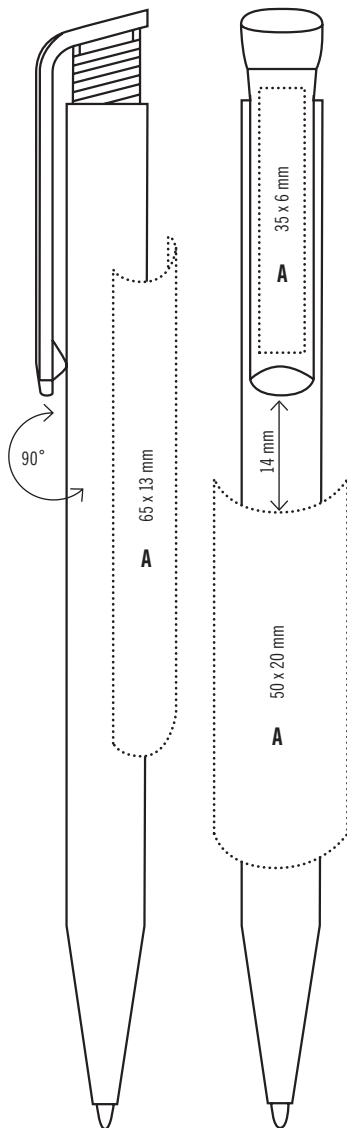

**A**  
SCREEN  
PRINT

COLOUR MIX  
PEN

**2331 COLOUR MIX PEN**

Lieferbare Kombinations-  
farben siehe Abbildung.

Available colour  
combinations see  
illustration.

Coloris de combinaison  
disponibles selon  
illustration.

Leverbare kleuren volgens  
afbeelding.

# SUPER-HIT



**NEW**



**NEW**

**NEW**

**NEW**

**NEW**

## 2244 ICY

Farben · Colours · Coloris · Kleuren

	icy
	PMS 1225 C
	PMS 1505 C
	PMS 201 C
	PMS 368 C
	PMS 286 C
	PMS 267 C
	PMS rhodamine red C
	PMS 418 C

## 2883 BASIC

Farben · Colours · Coloris · Kleuren

	white		PMS 288 C
	PMS 116 C		PMS 116 / 288 C
	PMS 485 C		PMS 116 / black
	PMS 349 C		PMS 226 C
	PMS 2935 C		PMS 144 C
	PMS 288 C		PMS 390 C
	black		PMS 285 C
			black

D

Druckkugelschreiber  
großer Clip  
Qualitätsmine,  
blau oder schwarz

**BASIC**  
opakes Gehäuse  
glänzend transparenter Clip

**CLEAR**  
Gehäuse und Clip glänzend  
transparent

GB

Economy retractable ballpen  
Large clip for branding impact  
Quality refill,  
blue or black

**BASIC**  
Opaque barrel  
Glossy transparent clip

**CLEAR**  
High gloss translucent  
barrel and clip

F

Stylo à bille rétractable,  
Large clip,  
Recharge de qualité,  
bleue ou noire

**BASIC**  
Corps opaque,  
Clip brillant transparent

**CLEAR**  
Corps et clip brillants  
transparents

NL

Balpen  
Brede clip  
Kwaliteitsvulling,  
blauw-, of zwartschrijvend

**BASIC**  
Opake houder  
Glanzend transparante clip

**CLEAR**  
Houder en clip glänzend  
transparent

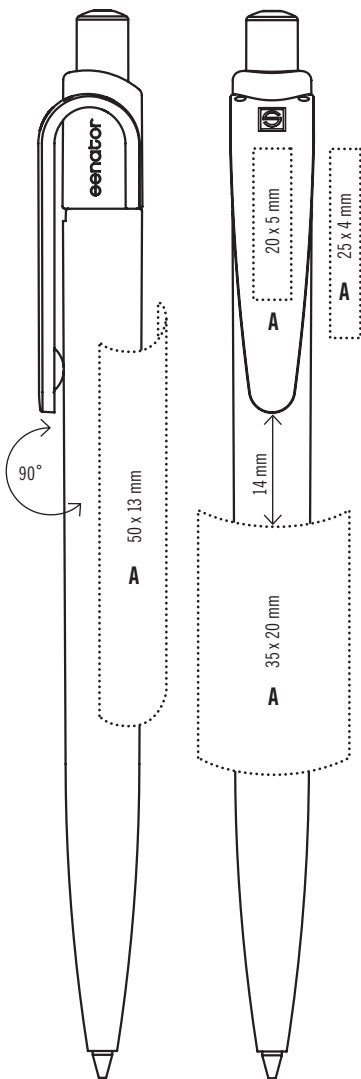

**2725 BASIC**

Farben · Colours · Coloris · Kleuren









- PMS 1225 C
- PMS 1505 C
- PMS 201 C
- PMS 3425 C
- PMS 286 C
- PMS 267 C

# SUNNY



## 2726 CLEAR

Farben · Colours · Coloris · Kleuren

	PMS 1225 C
	PMS 1505 C
	PMS 201 C
	PMS 3425 C
	PMS 286 C
	PMS 267 C

**D**

Druckkugelschreiber  
Qualitätsmine,  
blau oder schwarz

**ICC**  
individuelle PMS Farben

**BASIC**  
Gehäuse und Clip opak

**CLEAR**  
glänzend transparentes Gehäuse  
und opaker Clip

**GB**

Retractable ballpen  
Large opaque clip for branding impact  
Quality refill,  
blue or black

**ICC**  
individual pantone colours

**BASIC**  
Opaque barrel and clip

**CLEAR**  
High gloss transparent barrel  
and opaque clip

**F**

Stylo à bille rétractable,  
Recharge de qualité,  
bleue ou noire

**ICC**  
Couleurs PMS individuelles

**BASIC**  
Corps et clip opaques

**CLEAR**  
Corps transparent brillant  
et clip opaque

**NL**

Balpen  
Kwaliteitsvulling,  
blauw-, of zwartschrijvend

**ICC**  
individuele PMS kleuren

**BASIC**  
Opake houder en clip

**CLEAR**  
Glanzend transparante houder  
en opake clip

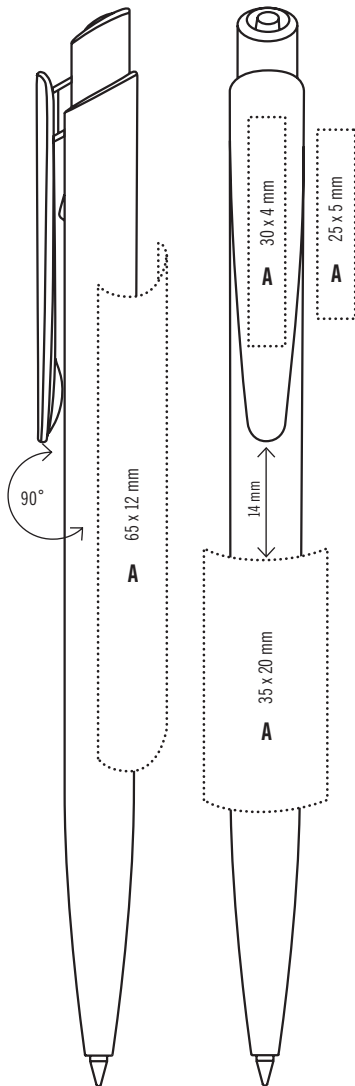

**ICC INDIVIDUAL COLOUR CONCEPT**

Individuelle opake  
Kunststofffarben bereits  
ab 5.000 Stück in  
PMS-Farbe realisierbar.  
Lieferung erfolgt an-  
nähernd der PMS-Farbe.

Customised colours  
available (opaque finish)  
from only 5,000 pieces.

Injection à la couleur  
Pantone souhaitée dès  
5000 pièces.

Individuele opake kunst-  
stofkleuren, al vanaf 5.000  
stuks in eigen PMS-kleur te  
realiseren.



# DART



## 2600 BASIC

Farben · Colours · Coloris · Kleuren



**NEW**

## 2602 CLEAR

Farben · Colours · Coloris · Kleuren



# METAL PENS

---

Eine perfekte Symbiose aus Tradition und Moderne. Das Design der Metal Pens ist außergewöhnlich edel und zeitlos. Verbunden mit einer innovativen Funktionalität, die der Zeit vorausgeht. Perfekt für einen ganz großen Auftritt!

A perfect symbiosis of the traditional and modern. The design of the Metal Pens is extraordinarily elegant and timeless, and also includes innovative functionality far ahead of its time. Perfect for an outstanding impression.

Une symbiose parfaite de la tradition et du moderne. La ligne des Metal Pens est exceptionnelle et intemporelle. En association avec un fonctionnement innovant en avance sur son temps. La perfection pour une belle présentation ciblée.

Een perfecte symbiose van traditioneel en modern. Het design van de METALEN PENNEN is buitengewoon geraffineerd en tijdloos. Vooroplopend in innovatie en functionaliteit. Perfect voor elke grootse presentatie.





D

Metallschreibgeräte  
schwarze Softgriffzone und  
verchromte Metallbeschläge

**STEEL**  
im Edelstahl-Finish

**ALU**  
hochwertige Metallic-Lackierung  
**Farben:**  
Schwarz, Blau, Anthrazit

GB

Metal writing instruments  
Black soft grip section and  
chrome metal trim

**STEEL**  
Stainless steel finish

**ALU**  
High-quality metallic lacquer  
**Colours:**  
black, blue, anthracite

F

Instruments d'écriture en métal,  
Zone de préhension souple noire  
et attributs en métal chromé

**STEEL**  
Aspect « acier inoxydable »

**ALU**  
Avec laque métallique  
**Coloris :**  
noir, bleu, anthracite

NL

Metalen schrijfwaren  
Zwarte softgripzone en  
verchromde beslagdelen

**STEEL**  
Edelstaal-finish

**ALU**  
Hoogwaardige metallic-laklaag  
**Kleuren:**  
zwart, blauw, anthraciet

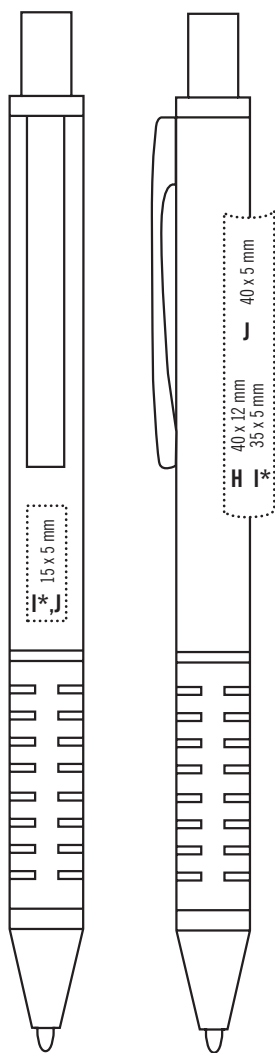

\* nur auf 2040, 3004

\* only on 2040, 3004

\* seulement sur 2040, 3004

\* uitsluitend op 2040, 3004



**2040 STEEL**

**2511 ALU**

DRUCKKUGELSCHREIBER  
Qualitäts-Metall-Großraummine, blau

RETRACTABLE BALLPEN  
Large capacity metal quality refill, blue

STYLO A BILLE RETRACTABLE  
Recharge de qualité de grande capacité,  
en métal, bleue

BALPEN  
Metalen kwaliteitsvulling (langschrijfvulling),  
blauwschrijvend

# SOFTSTAR



## 6342 ALU Set

Druckkugelschreiber und Druckbleistift  
im Etui

Retractable ballpen and mechanical pencil  
in case

Stylo à bille rétractable et porte-mines,  
en étui

Balpen en vulpotlood in etui



## 6341 STEEL Set

Druckkugelschreiber und Druckbleistift  
im Etui

Retractable ballpen and mechanical pencil  
in case

Stylo à bille rétractable et porte-mines,  
en étui

Balpen en vulpotlood in etui



## 3004 STEEL

DRUCKBLEISTIFT  
0,5 mm Hi-Polymer Bleistiftmine

MECHANICAL PENCIL  
0.5 mm Hi-Polymer pencil lead

PORTE-MINES  
Mine Hi polymère 0,5 mm

VULPOTLOOD  
0,5 mm Hi-Polymer vulpotloodvulling



## 3111 ALU



**D**

Metallschreibgeräte  
vergoldete Metallbeschläge

**Farben:**  
Edelstahl-Finish, Schwarz

**GB**

Metal writing instruments  
Gilt fittings

**Colours:**  
stainless steel finish, black

**F**

Instruments d'écriture en métal  
Attributs en métal dorés

**Coloris :**  
aspect « acier inoxydable », noir

**NL**

Metalen schrijfwaren  
Vergulde metalen beslagdelen

**Kleuren:**  
edelstaal-finish, zwart

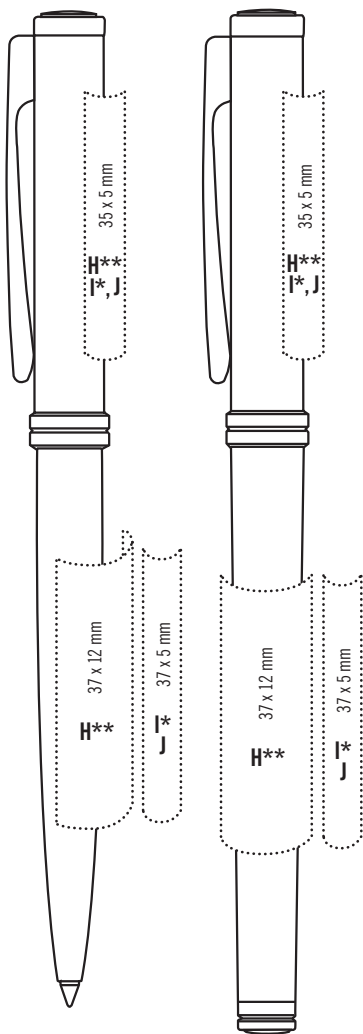

**6095 CLASSIC Set**

Füllhalter und Druckkugelschreiber  
im Etui, Edelstahl-Finish

Fountain pen and retractable ballpen  
in case, stainless steel finish

Stylo à plume et stylo à bille rétractable,  
en étui, aspect « acier inoxydable »

Vulpen en balpen in etui, edelstaal-finish



**6096 CLASSIC Set**

Füllhalter und Druckkugelschreiber  
im Etui, schwarz

Fountain pen and retractable ballpen  
in case, black

Stylo à plume et stylo à bille rétractable,  
en étui, noir

Vulpen en balpen in etui, zwart

**6100 CLASSIC Set**

Rollerball und Druckkugelschreiber  
im Etui, Edelstahl-Finish

Rollerball and retractable ballpen  
in case, stainless steel finish

Rollerball et stylo à bille rétractable,  
en étui, aspect « acier inoxydable »

Rollerball en balpen in etui, edelstaal-finish

**6101 CLASSIC Set**

Rollerball und Druckkugelschreiber  
im Etui, schwarz

Rollerball and retractable ballpen  
in case, black

Rollerball et stylo à bille rétractable,  
en étui, noir

Rollerball en balpen in etui, zwart

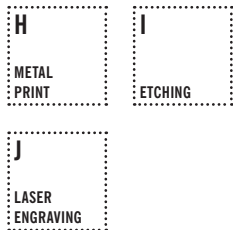

\* nur auf 0031, 1029, 2239  
\*\* nur 1-farbig

\* only on 0031, 1029, 2239  
\*\* 1 colour only

\* seulement sur 0031, 1029, 2239  
\*\* 1 couleur seulement

\* uitsluitend op 0031, 1029, 2239  
\*\* uitsluitend in 1 kleur

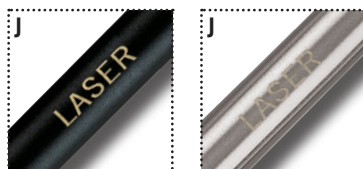

# DELGADO

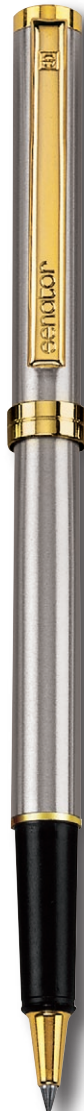

## 0031 CLASSIC

FÜLLHALTER  
Edelstahlfeder mit Iridiumspitze (M)

FOUNTAIN PEN  
Iridium-tipped nib (M)

STYLO A PLUME  
Plume en acier à pointe iridium (M)

VULPEN  
Edelstalen, vergulde iridium punt (M)

## 0032 CLASSIC

## 1029 CLASSIC

ROLLERBALL  
Safety-Roller-Metallmine, blau

ROLLERBALL  
Metal safety-roller-refill, blue

ROLLERBALL  
Recharge roller métal sécurité, bleue.

ROLLERBALL  
Safety-Rollerballvulling, blauwschrijvend

## 1030 CLASSIC

## 2239 CLASSIC

DRUCKKUGELSCHREIBER  
Qualitäts-Metall-Großraummine, blau

RETRACTABLE BALLPEN  
Large capacity metal quality refill, blue

STYLO A BILLE RETRACTABLE  
Recharge de qualité de grande capacité,  
en métal, bleue

BALPEN  
Metalen kwaliteitsvulling (langschrijfvulling),  
blauwschrijvend

## 2240 CLASSIC

**D**

Metallschreibgeräte  
verchromte Metallbeschläge

**METALLIC**

**Farben:**  
Anthrazit, Blau

**STEEL**

**Farbe:**  
Edelstahl-Finish

**GB**

Metal writing instruments  
Chrome metal trim

**METALLIC**

**Colours:**  
anthracite, blue

**STEEL**

**Colour:**  
stainless steel finish

**F**

Instruments d'écriture en métal  
Attributs en métal chromé brillant

**METALLIC**

**Coloris :**  
anthracite, bleu

**STEEL**

**Colori :**  
aspect « acier inoxydable »

**NL**

Metalen schrijfwaren  
Verchromde metalen beslagdelen

**METALLIC**

**Kleuren:**  
anthraciet, blauw

**STEEL**

**Kleur:**  
edelstaal-finish

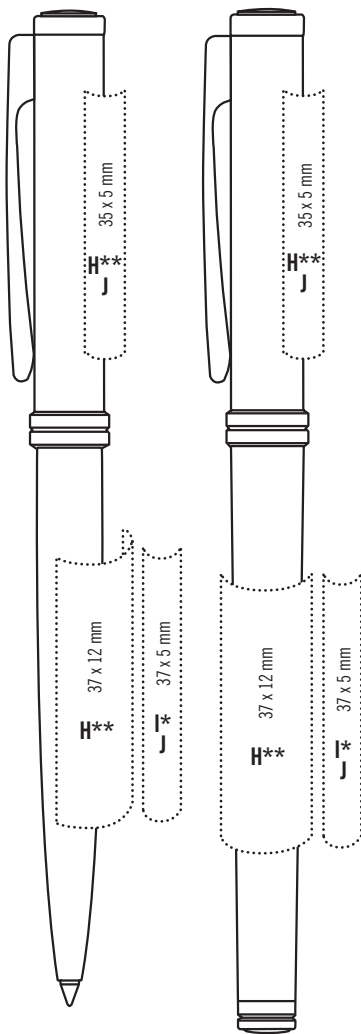

**6104 STEEL Set**

Füllhalter und Druckkugelschreiber  
im Etui

Fountain pen and retractable ballpen  
in case

Stylo à plume et stylo à bille rétractable,  
en étui

Vulpen en balpen in etui



**6097 METALLIC Set**

Füllhalter und Druckkugelschreiber  
im Etui

Fountain pen and retractable ballpen  
in case

Stylo à plume et stylo à bille rétractable,  
en étui

Vulpen en balpen in etui

**6114 STEEL Set**

Rollerball und Druckkugelschreiber  
im Etui

Rollerball and retractable ballpen  
in case

Rollerball et stylo à bille rétractable,  
en étui

Rollerball en balpen in etui

**6102 METALLIC Set**

Rollerball und Druckkugelschreiber  
im Etui

Rollerball and retractable ballpen  
in case

Rollerball et stylo à bille rétractable,  
en étui

Rollerball en balpen in etui

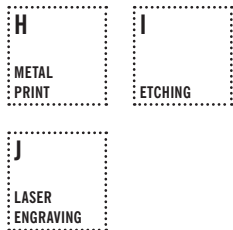

\* nur auf 0039, 1039, 2242  
\*\* nur 1-farbig

\* only on 0039, 1039, 2242  
\*\* 1 colour only

\* seulement sur 0039, 1039, 2242  
\*\* une couleur seulement

\* uitsluitend op 0039, 1039, 2242  
\*\* uitsluitend in 1 kleur





# DELGADO



## 0033 METALLIC

FÜLLHALTER  
Edelstahlfeder mit Iridiumspitze (M)

FOUNTAIN PEN  
Iridium-tipped nib (M)

STYLO A PLUME  
plume en acier à pointe iridium (M)

VULPEN  
Edelstalen iridium punt (M)

## 0039 STEEL

## 1031 METALLIC

ROLLERBALL  
Safety-Roller-Metallmine, blau

ROLLERBALL  
Metal safety-roller-refill, blue.

ROLLERBALL  
recharge roller métal sécurité, bleue.

ROLLERBALL  
Safety-Rollerballvulling, blauw schrijvend

## 1039 STEEL

## 2241 METALLIC

DRUCKKUGELSCHREIBER  
Qualitäts-Metall-Großraummine, blau

RETRACTABLE BALLPEN  
Large capacity metal quality refill, blue

STYLO A BILLE A MECANISME TOURNANT  
Recharge de qualité de grande capacité,  
en métal, bleue

BALPEN MET SCHUIFKAP MECHANIEK  
Metalen kwaliteitsvulling (langschrijfvulling),  
blauw schrijvend

## 2242 STEEL

D

Metallschreibgeräte  
hochwertige Lackierung  
glänzend verchromte Metallbeschläge

**Farben:**  
Blau, Schwarz

GB

Metal writing instruments  
High-gloss lacquer finish  
Chrome-plated metal barrel

**Colours:**  
blue, black

F

Instruments d'écriture en métal,  
Laque ultra brillante,  
Attributs en métal chromé brillant

**Coloris :**  
bleu, noir

NL

Metalen schrijfwaren  
Hoogwaardige laklaag  
Glanzend verchromde beslagdelen

**Kleuren:**  
blauw, zwart

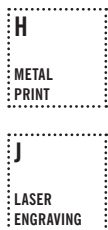
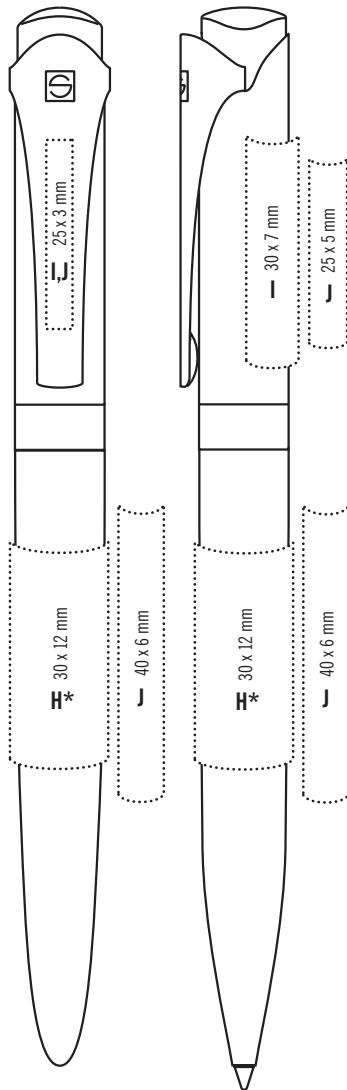

\* nur 1-farbig  
 \* 1 colour only  
 \* une couleur seulement  
 \* uitsluitend in 1 kleur



**6193 VISIR Set**

Füllhalter und Drehkugelschreiber  
im Etui

Fountain pen and twist-mechanism ballpen  
in case

Stylo à plume et stylo à bille à mécanisme  
tournant, en étui

Vulpen en balpen in etui



**6194 VISIR Set**

Rollerball und Drehkugelschreiber  
im Etui

Rollerball and twist-mechanism  
ballpen in case

Rollerball et stylo à bille à  
mécanisme tournant, en étui

Rollerball en balpen in etui



## 0056 VISIR

FÜLLHALTER  
Edelstahlfeder mit Iridiumspitze (M)

FOUNTAIN PEN  
Iridium-tipped nib (M)

STYLO A PLUME  
Plume en acier à pointe iridium (M)

VULPEN  
Edelstalen iridium punt (M)

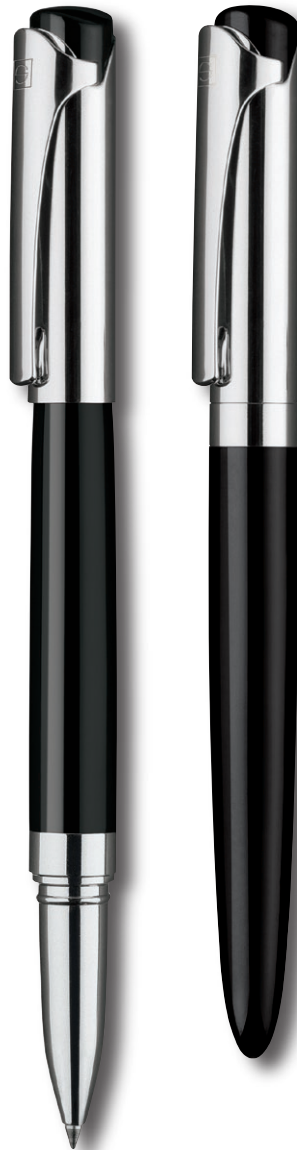

## 1056 VISIR

ROLLERBALL  
Safety-Roller-Metallmine, blau

ROLLERBALL  
Metal safety-roller-refill, blue

ROLLERBALL  
Recharge roller métal sécurité, écriture bleue

ROLLERBALL  
Safety-Rollerballvulling, blauwschrijvend



## 2253 VISIR

DREHKUGELSCHREIBER  
Qualitäts-Metall-Großraummine, blau

TWIST-MECHANISM BALLPEN  
Large capacity metal quality refill, blue

STYLO A BILLE A MECANISME TOURNANT  
Recharge de qualité de grande capacité,  
en métal, bleue

DRAAIBALPEN  
Metalen kwaliteitsvulling (langschrijfvulling),  
blauwschrijvend

D

**NAUTIC**

Metallgehäuse,  
matt verchromt  
Soft-Lackierung  
**Farben:**  
Blau, Schwarz

**LEGACY**

Metallgehäuse,  
verchromt  
Softgriffzone  
**Farben:**  
Schwarz, Silber

GB

**NAUTIC**

Metal matt chrome barrel  
Coloured, soft lacquered trim  
**Colours:**  
blue, black

**LEGACY**

Metal matt chrome barrel  
Coloured, soft lacquered trim  
**Colours:**  
black, silver

F

**NAUTIC**

Corps en métal chromé,  
Laque souple  
**Coloris :**  
bleu, noir

**LEGACY**

Corps en métal chromé mat  
Zone de préhension  
ergonomique souple  
**Coloris :**  
noir, argent

NL

**NAUTIC**

Metalen schrijfwaren,  
mat verchromde delen  
Soft-Laklaag  
**Kleuren:**  
blauw, zwart

**LEGACY**

Metalen schrijfwaren,  
verchromde delen  
Softgripzone  
**Kleuren:**  
zwart, zilver

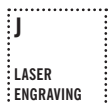
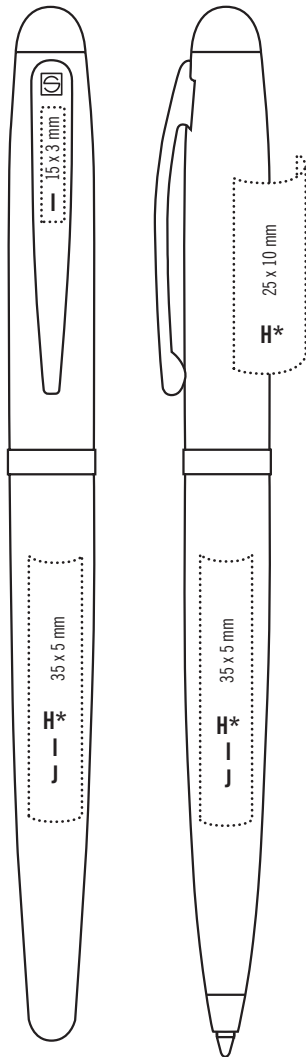

- \* nur 1-farbig
- \* 1 colour only
- \* 1 couleur seulement
- \* uitsluitend in 1 kleur

**1092 NAUTIC**

ROLLERBALL  
Safety-Roller-Metallmine, blau

ROLLERBALL  
Metal safety-roller-refill, blue

ROLLERBALL  
recharge roller métal sécurité, bleue

ROLLERBALL  
Safety-Rollerballvulling, blauwschrijvend

**2215 NAUTIC**

DREHKUGELSCHREIBER  
Qualitäts-Metall-Großraummine, blau

TWIST-MECHANISM BALLPEN  
Large capacity metal quality refill, blue

STYLO A BILLE A MECANISME TOURNANT  
recharge de qualité de grande capacité,  
en métal, bleue

DRAAIBALPEN  
Metalen kwaliteitsvulling (langschrijfvulling),  
blauwschrijvend

# NAUTIC LEGACY

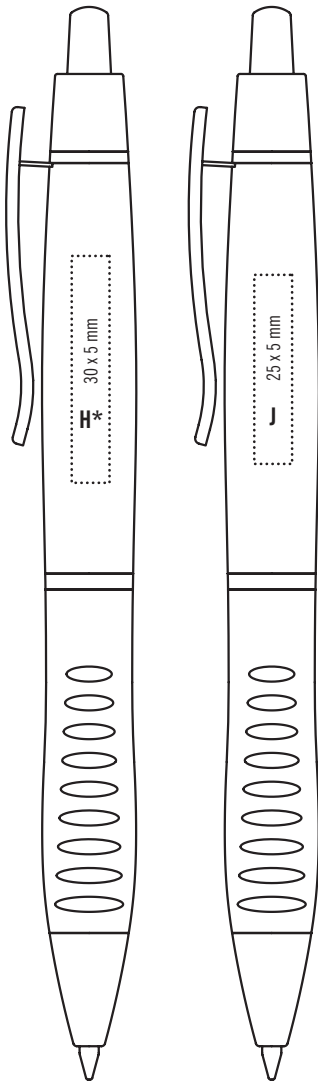

- \* nur 1-farbig
- \* 1 colour only
- \* 1 couleur seulement
- \* uitsluitend in 1 kleur



## 2788 LEGACY

DRUCKKUGELSCHREIBER  
Qualitäts-Metall-Großraummine, blau

RETRACTABLE BALLPEN  
Large capacity metal quality refill, blue

STYLO A BILLE RETRACTABLE  
Recharge de qualité de grande capacité,  
en métal bleue

BALPEN  
Metalen kwaliteitsvulling (langschrijfvulling),  
blauwschrijvend

D

Metallschreibgeräte  
hochwertige Matt-Lackierung  
vergoldete Metallbeschläge

**Farben:**  
Schwarz

GB

Metal writing instruments  
High-quality matt lacquer  
Gilt metal fittings

**Colour:**  
black

F

Instruments d'écriture en métal,  
Métal laqué de haute qualité

**Coloris :**  
noir

NL

Metalen schrijfwaren  
Hoogwaardige laklaag  
Vergulde metalen beslagdelen

**Kleur:**  
zwart

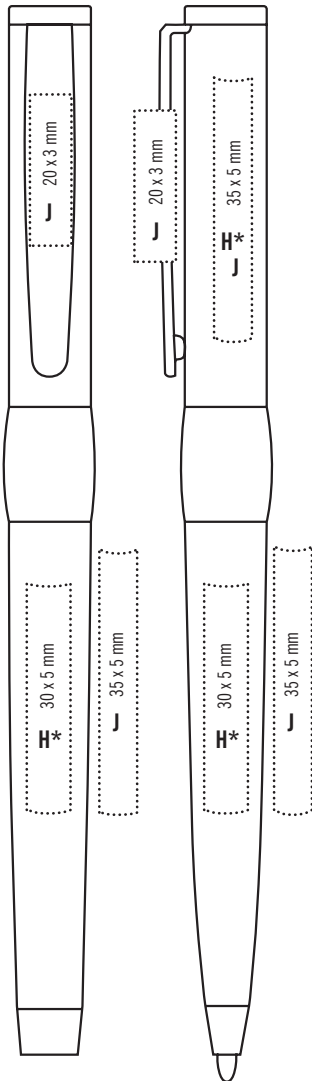

**6201 CLASSIC Set**

Füllhalter, Drehkugelschreiber und Lederetui  
in schwarzer Kartonschachtel

Fountain pen, twist-mechanism ballpen  
and leather wallet in black carded box

Stylo à plume, stylo à bille à mécanisme tournant  
et étui en cuir, en boîte carton

Vulpen, draaibalpen en lederen etui  
in zwarte kartonnen verpakking



**6203 CLASSIC Set**

Füllhalter und Drehkugelschreiber  
im Etui.

Fountain pen and twist-mechanism ballpen in case

Stylo à plume et stylo à bille à mécanisme tournant,  
en étui.

Vulpen en draaibalpen in etui

**6202 CLASSIC Set**

Rollerball, Drehkugelschreiber und Lederetui  
in schwarzer Kartonschachtel

Rollerball, twist-mechanism ballpen  
and leather wallet in black carded box

Rollerball, stylo à bille à mécanisme tournant  
et étui en cuir, en boîte carton

Rollerball, draaibalpen en lederen etui  
in zwarte kartonnen verpakking

**6204 CLASSIC Set**

Rollerball und Drehkugelschreiber  
im Etui

Rollerball and twist-mechanism  
ballpen in case

Rollerball et stylo à bille à mécanisme tournant,  
en étui.

Rollerball en draaibalpen in etui



\* nur 1-farbig

\* 1 colour only

\* 1 couleur seulement

\* uitsluitend in 1 kleur





## 0073 CLASSIC

FÜLLHALTER  
Ziselierter, vergoldeter Edelstahlfeder  
mit Iridiumspitze (M)

FOUNTAIN PEN  
Embellished, gilt iridium tipped stainless steel nib (M)

STYLO A PLUME  
Plume en acier inoxydable doré, ciselé,  
à pointe iridium (M)

VULPEN  
Versierde, vergulde edelstalen iridium punt (M)



## 1160 CLASSIC

ROLLERBALL  
Safety-Roller-Metallmine, blau

ROLLERBALL  
Metal safety-roller-refill, blue

ROLLERBALL  
Recharge roller métal sécurité, écriture bleue.

ROLLERBALL  
Safety-Rollerballvulling, blauw schrijvend



## 2160 CLASSIC

DREHKUGELSCHREIBER  
Qualitäts-Metall-Großraummine, blau

TWIST-MECHANISM BALLPEN  
Large capacity metal quality refill, blue

STYLO A BILLE A MECANISME TOURNANT  
Recharge de qualité de grande capacité,  
en métal, bleue

DRAAIBALPEN  
Metalen kwaliteitsvulling (langschrijfvulling),  
blauw schrijvend

**D**

Metallschreibgeräte  
hochwertige Soft-Lackierung

**CHROME**  
matt verchromte Beschlagteile  
**Farben:**  
Silber, Blau

**BLACK LINE**  
schwarz verchromte Beschlagteile  
**Farben:**  
Schwarz

**GB**

Metal writing instruments  
High-quality matt lacquer

**CHROME**  
Matt chrome fittings  
**Colours:**  
silver, blue

**BLACK LINE**  
black chrome fittings  
**Colours:**  
black

**F**

Instruments d'écriture en métal,  
Métal laqué de haute qualité,

**CHROME**  
Attributs en métal chromé mat  
**Coloris :**  
argent, bleu

**BLACK LINE**  
Attributs en métal chromé noir  
**Couleur :**  
noir

**NL**

Metalen schrijfwaren  
Hoogwaardige laklaag

**CHROME**  
Mat-verchromde beslagdelen  
**Kleuren:**  
zilver, blauw

**BLACK LINE**  
zwart verchromde beslagdelen  
**Kleuren:**  
zwart

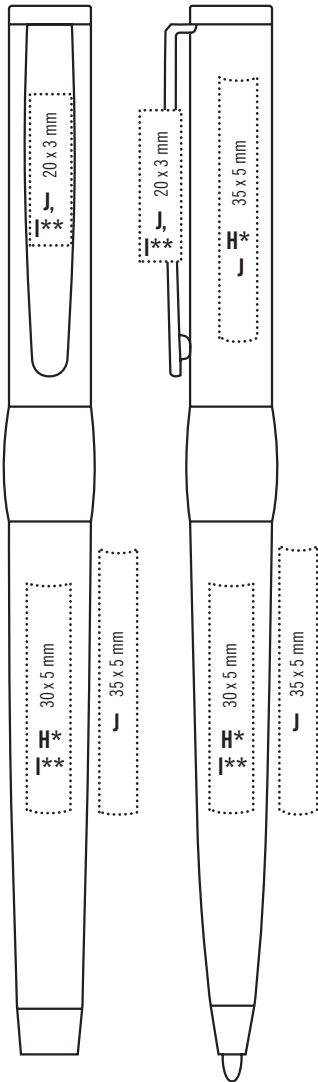

**6117 CHROME Set**

Füllhalter, Drehkugelschreiber und Lederetui  
in schwarzer Kartonschachtel

Fountain pen, twist-mechanism ballpen  
and leather wallet in black cardboard box

Stylo à plume, stylo à bille à mécanisme tournant  
et étui en cuir, en boîte carton

Vulpen, draaibalpen en lederen etui  
in zwarte kartonnen verpakking



**6237 CHROME Set**

Füllhalter und Drehkugelschreiber  
im Etui.

Fountain pen and twist-mechanism ballpen  
in case

Stylo à plume et stylo à bille à mécanisme  
tournant, en étui.

Vulpen en draaibalpen in etui

**6089 CHROME Set**

Rollerball, Drehkugelschreiber und Lederetui  
in schwarzer Kartonschachtel

Rollerball, twist-mechanism ballpen  
and leather wallet in black cardboard box

Rollerball, stylo à bille à mécanisme tournant  
et étui en cuir, en boîte carton

Rollerball, draaibalpen en lederen etui  
in zwarte kartonnen verpakking

**6238 CHROME Set**

Rollerball und Drehkugelschreiber  
im Etui

Rollerball and twist-mechanism ballpen  
in case

Rollerball et stylo à bille à mécanisme  
tournant, en étui.

Rollerball en draaibalpen in etui



**6205 BLACK LINE Set**

Füllhalter und Drehkugelschreiber im Etui.

Fountain pen and twist-mechanism ballpen in case

Stylo à plume et stylo à bille à mécanisme tournant,  
en étui.

Vulpen en draaibalpen in etui

**6206 BLACK LINE Set**

Rollerball und Drehkugelschreiber im Etui.

Rollerball and twist-mechanism ballpen in case

Rollerball et stylo à bille à mécanisme tournant,  
en étui.

Rollerball en draaibalpen in etui

\* nur 1-farbig  
\*\* nur auf 0075, 1036, 2158

\* 1 colour only  
\*\* only on 0075, 1036, 2158

\* 1 couleur seulement  
\*\* seulement sur  
0075, 1036, 2158

\* uitsluitend in 1 kleur  
\*\* uitsluitend op  
0075, 1036, 2158

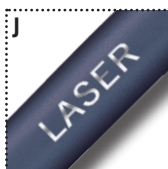
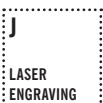



# IMAGE



## 0075 CHROME

FÜLLHALTER  
Ziselierter Edelstahlfeder mit Iridiumspitze (M)

FOUNTAIN PEN  
Embellished, iridium tipped stainless steel nib (M)

STYLO A PLUME  
Plume en acier inoxydable à pointe iridium (M)

VULPEN  
Versierde, edelstalen iridium punt (M)

## 0104 BLACK LINE

## 1036 CHROME

ROLLERBALL  
Safety-Roller-Metallmine, blau

ROLLERBALL  
Metal safety-roller-refill, blue

ROLLERBALL  
Recharge roller métal sécurité, bleue

ROLLERBALL  
Safety-Rollerballvulling, blauw schrijvend

## 1119 BLACK LINE

## 2158 CHROME

DRUCKKUGELSCHREIBER  
Qualitäts-Metall-Großraummine, blau

TWIST-MECHANISM BALLPEN  
Large capacity metal quality refill, blue

STYLO A BILLE A MECANISME TOURNANT  
Recharge de qualité de grande capacité, en métal, bleue

DRAAIBALPEN  
Metalen kwaliteitsvulling (langschrijfvulling), blauw schrijvend

## 2636 BLACK LINE

D

Metallschreibgeräte mit transparenter Kunststoffummantelung

**CHROME**

glänzend verchromte Metallbeschlägeteile

**Farben:**  
Anthrazit

**SOLARIS**

matt verchromte Metallbeschlägeteile

**Farben:**  
Rot, Blau

GB

Metal writing instruments with contrasting coloured barrel

**CHROME**

Gloss chrome metal trim

**Colour:**  
anthracite

**SOLARIS**

Matt chrome trim

**Colours:**  
red, blue

F

Instruments d'écriture en métal habillé de plastique transparent

**CHROME**

Attributs chromés brillants

**Coloris :**  
anthracite

**SOLARIS**

Attributs chromé mat

**Coloris :**  
rouge, bleu

NL

Metalen schrijfwaren met transparante kunststof buitenhuls

**CHROME**

Glanzend verchromde metalen beslagdelen

**Kleur:**  
Anthraciet

**SOLARIS**

Mat verchromde metalen beslagdelen

**Kleuren:**  
rood, blauw

brigg | design

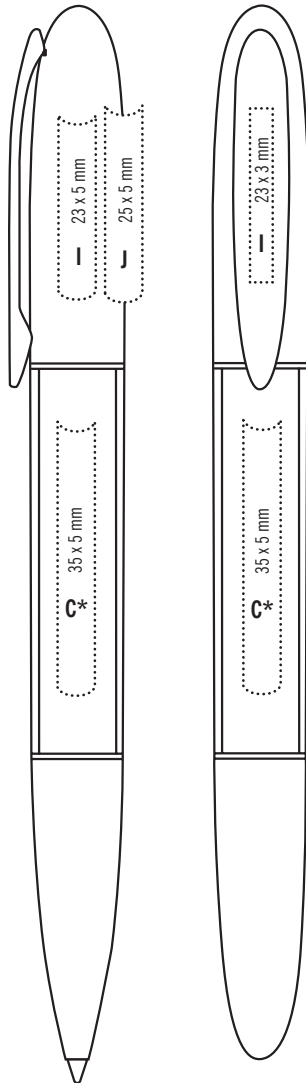

product design award

2006



DESIGNPREIS 2007

NOMINEE

Designpreis der BRD  
Design Award of the FRG



As awarded by The Chicago Athenaeum  
Museum of Architecture and Design



**1479 SOLARIS CHROME**

ROLLERBALL  
Safety-Roller-Metallmine, blau

ROLLERBALL  
Metal safety-roller-refill, blue

ROLLERBALL  
Recharge roller métal sécurité, bleue

ROLLERBALL  
Safety-Rollerballvulling, blauwschrijvend

**2479 SOLARIS CHROME**

DREHKUGELSCHREIBER  
Qualitäts-Metall-Großraummine, blau

TWIST-MECHANISM BALLPEN.  
Large capacity metal quality refill, blue

STYLO A BILLE A MECANISME TOURNANT  
Recharge de qualité de grande capacité, en métal, bleue

DRAAIBALPEN  
Metalen kwaliteitsvulling (langschrijfvulling), blauwschrijvend



\* nur 1-farbig

\* 1 colour only

\* 1 couleur seulement

\* uitsluitend in 1 kleur

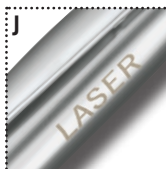

# SOLARIS CHROME

---

# SOLARIS



## 6178 SOLARIS Set

Rollerball und Druckkugelschreiber  
im Etui

Rollerball and twist-mechanism ballpen in case

Rollerball et stylo à bille à mécanisme tournant,  
en étui

Rollerball en draaibalpen in etui

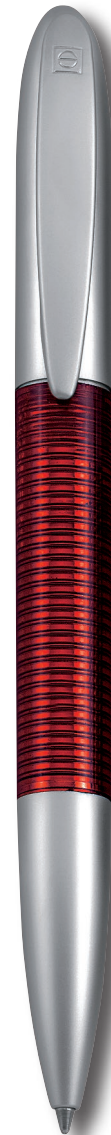
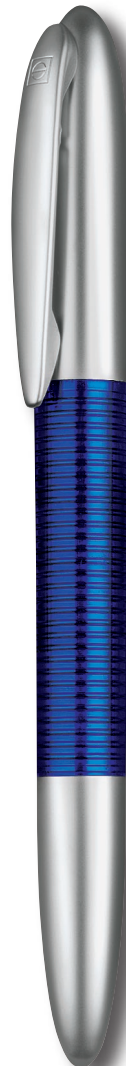

## 6480 SOLARIS CHROME Set

Rollerball und Druckkugelschreiber  
im Etui

Rollerball and twist-mechanism ballpen in case

Rollerball et stylo à bille à mécanisme tournant,  
en étui

Rollerball en draaibalpen in etui

## 1143 SOLARIS

ROLLERBALL  
Safety-Roller-Metallmine, blau

ROLLERBALL  
Metal safety-roller-refill, blue

ROLLERBALL  
Recharge roller sécurité, en métal, bleue.

ROLLERBALL  
Safety-Rollerballvulling, blauwschrijvend

## 2427 SOLARIS

DREHKUGELSCHREIBER  
Qualitäts-Metall-Großraummine, blau

TWIST-MECHANISM BALLPEN  
Large capacity metal quality refill, blue

STYLO A BILLE A MECANISME TOURNANT  
Recharge de qualité de grande capacité,  
en métal, bleue

DRAAIBALPEN  
Metalen kwaliteitsvulling (langschrijfvulling),  
blauwschrijvend

D

Metallschreibgeräte,  
hochglanzverchromt in  
Kombination mit Nussbaumholz

GB

Classic writing instruments crafted from  
sustainable nutwood with chrome trim

F

Instruments d'écriture avec corps en  
métal chromé mat, combiné avec du  
bois (essence de noyer)

NL

Metalen schrijfwaren, glanzend  
verchroomd in combinatie met  
notenhout

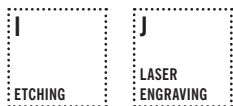
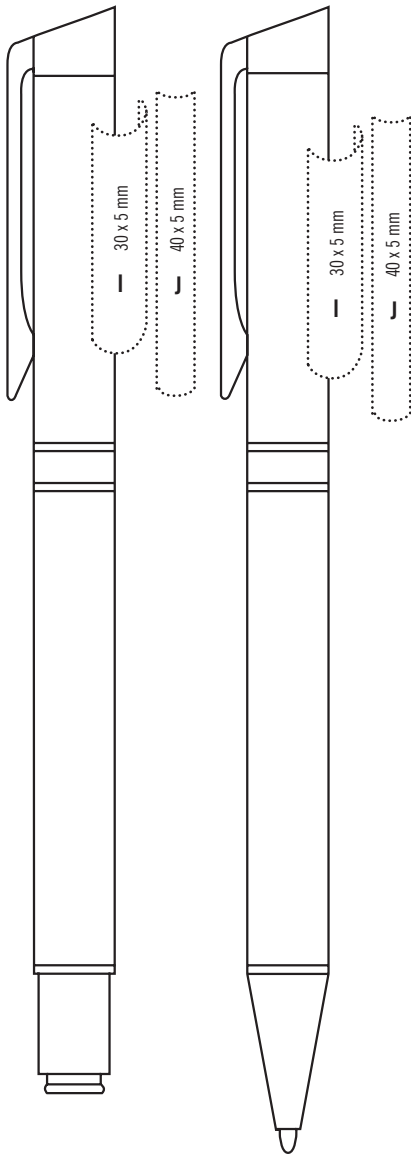

**6252 TIZIO Set**

Füllhalter und Drehkugelschreiber  
im Etui

Fountain pen and twist-mechanism ballpen in case

Stylo à plume et stylo à bille à mécanisme tournant,  
en étui

Vulpen en draaibalpen in etui

**6253 TIZIO Set**

Rollerball und Drehkugelschreiber  
im Etui

Rollerball and twist-mechanism ballpen in case

Rollerball et stylo à bille à mécanisme tournant,  
en étui

Rollerball en draaibalpen in etui



## 0240 TIZIO

FÜLLHALTER  
Edelstahlfeder mit Iridiumspitze (M)

FOUNTAIN PEN  
Iridium-tipped stainless steel nib(M)

STYLO A PLUME  
Plume en acier à pointe iridium (M)

VULPEN  
Edelstalen iridium punt (M)



## 1240 TIZIO

ROLLERBALL  
Safety-Roller-Metallmine, blau

ROLLERBALL  
Metal safety-roller-refill, blue

ROLLERBALL  
Recharge roller sécurité, écriture bleue.

ROLLERBALL  
Safety-Rollerballvulling, blauwschrijvend



## 2400 TIZIO

DREHKUGELSCHREIBER  
Qualitäts-Metall-Großraummine, blau

TWIST MECHANISM BALLPEN  
Large capacity metal quality refill, blue

STYLO A BILLE A MECANISME TOURNANT  
Recharge de qualité de grande capacité

DRAAIBALPEN  
Metalen kwaliteitsvulling (langschrijfvulling),  
blauwschrijvend

D

Metallschreibgeräte,  
matt verchromt in Kombination  
mit leichtem Carbon

GB

Metal writing instruments combining  
carbon finish with chrome trim

F

Instruments d'écriture avec corps en  
métal chromé mat, combiné avec  
carbone léger.

NL

Metalen schrijfwaren, mat verchromd  
in combinatie met licht carbon

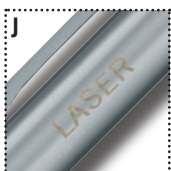
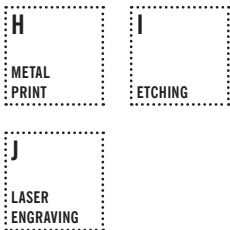
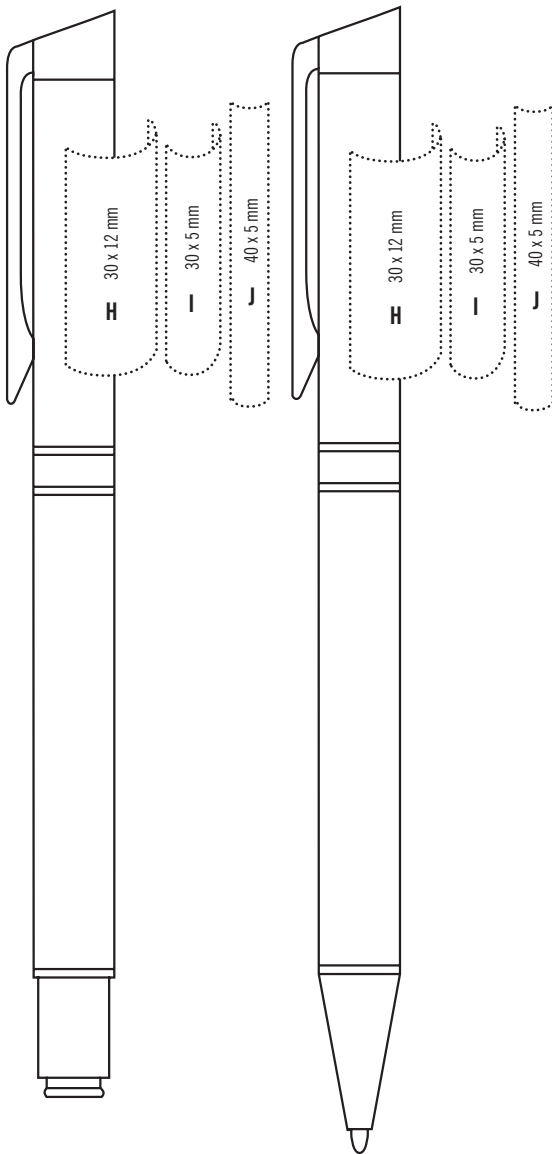

**6239 CARBON LINE Set**

Füllhalter und Drehkugelschreiber  
im Etui

Fountain pen and twist-mechanism ballpen in case

Stylo à plume et stylo à bille à mécanisme tournant  
présentés en étui

Vulpen en draaibalpen in etui

**6240 CARBON LINE Set**

Rollerball und Drehkugelschreiber  
im Etui

Rollerball and twist-mechanism ballpen in case

Rollerball et stylo à bille à mécanisme tournant  
présentés en étui

Rollerball en draaibalpen in etui

# CARBON LINE

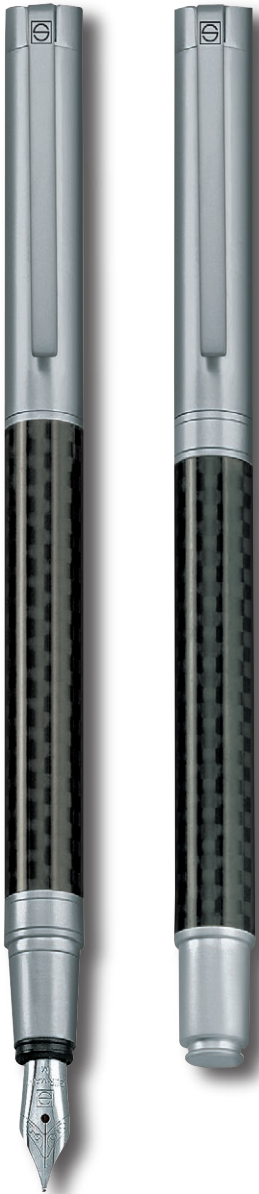

## 0076 CARBON LINE

FÜLLHALTER  
Edelstahlfeder mit Iridiumspitze (M)

FOUNTAIN PEN  
Iridium-tipped stainless steel nib (M)

STYLO A PLUME  
Plume en acier à pointe iridium (M)

VULPEN  
Edelstalen iridium punt (M)



## 1037 CARBON LINE

ROLLERBALL  
Safety-Roller-Metallmine, blau

ROLLERBALL  
Metal safety-roller-refill, blue

ROLLERBALL  
Recharge roller métal sécurité, écriture bleue.

ROLLERBALL  
Safety-Rollerballvulling, blauwschrijvend



## 2159 CARBON LINE

DREHKUGELSCHREIBER  
Qualitäts-Metall-Großraummine, blau

TWIST MECHANISM BALLPEN  
Large capacity metal quality refill, blue

STYLO A BILLE A MECANISME TOURNANT  
Recharge de qualité de grande capacité,  
en métal, bleue

DRAAIBALPEN  
Metalen kwaliteitsvulling (langschrijfvulling),  
blauwschrijvend

**D**  
 Metallschreibgeräte  
 aus eloxiertem Aluminium  
 verchromte Metallbeschläge

**Farbe:**  
 Silber

**GB**  
 Metal writing instruments  
 Anodised aluminium barrel  
 Chrome trim

**Colour:**  
 silver

**F**  
 Instruments d'écriture avec corps  
 en aluminium anodisé  
 Attributs en métal chromé brillant

**Coloris :**  
 argent

**NL**  
 Metalen schrijfwaren  
 Bewerkte aluminium houder  
 verchromde metalen beslagdelen

**Kleur:**  
 zilver

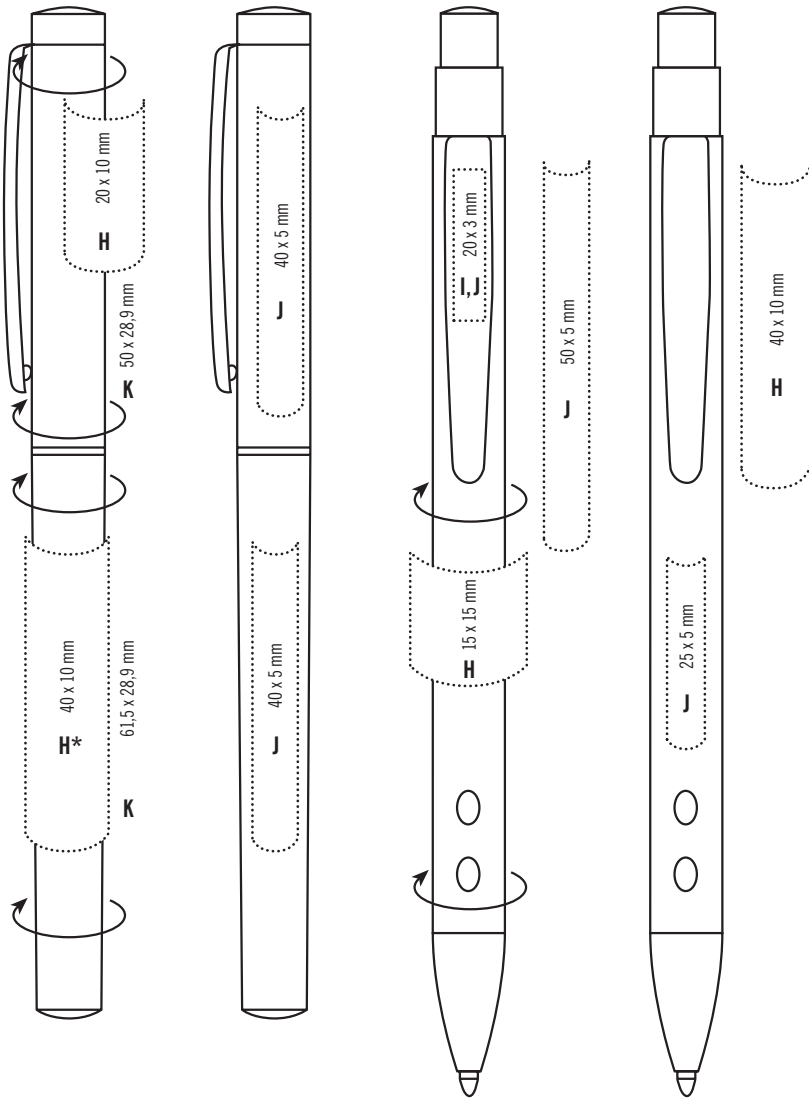

**6163 SILVER-LINE Set**

Rollerball und Druckkugelschreiber  
 im Etui

Rollerball and retractable ballpen in case

Rollerball et stylo à bille rétractable, en étui

Rollerball en balpen in etui

**6164 SILVER-LINE Set**

Druckbleistift und Druckkugel-  
 schreiber im Etui

Mechanical pencil and retractable ballpen in case

Porte-mines et stylo à bille rétractable, en étui

Vulpotlood en balpen in etui

<b>H</b> METAL PRINT	<b>I</b> ETCHING
<b>J</b> LASER ENGRAVING	<b>K</b> CHEMO PRINT

- \* nur 1-farbig
- \* 1 colour only
- \* 1 couleur seulement
- \* uitsluitend in 1 kleur

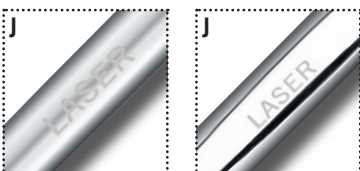



# SILVER-LINE



## 1079 SILVER-LINE

ROLLERBALL  
Safety-Roller-Metallmine, blau

ROLLERBALL  
Metal safety-roller-refill, blue

ROLLERBALL  
Recharge roller métal sécurité, bleue.

ROLLERBALL  
Safety-Rollerballvulling, blauwschrijvend



## 2379 SILVER-LINE

DRUCKKUGELSCHREIBER  
Qualitäts-Metall-Großraummine, blau

RETRACTABLE BALLPEN  
Large capacity metal quality refill, blue

STYLO A BILLE RETRACTABLE  
Recharge de qualité de grande capacité,  
en métal, bleue

BALPEN  
Metalen kwaliteitsvulling (langschrijfvulling),  
blauwschrijvend



## 3179 SILVER-LINE

DRUCKBLEISTIFT  
Voll versenkbare Minenführung  
0,7 mm Hi-Polymer-Bleistiftmine

MECHANICAL PENCIL  
Fully retractable lead tube,  
0,7 mm Hi-Polymer pencil lead.

PORTE-MINES  
Mécanisme rétractable,  
mine de crayon Hi Polymère de 0,7 mm

VULPOTLOOD  
Inzinkbare  
0,7 mm Hi-Polymeer vulpotloodvulling

D

Kolbenfüllhalter  
aus hochglänzendem Acryl  
diamantierte Beschlagteile  
aus vergoldetem Metall  
Sicherheitskappe für  
Kolbenfüllmechanik

GB

Piston filling fountain pen  
High-gloss acrylic with gilt,  
metal diamond-finished fittings  
Security cap to protect piston  
filling system.

F

Stylo à plume à piston en  
acrylique ultra brillant  
Attributs en métal doré diamantés  
Système de remplissage protégé  
par un capuchon.

NL

Converter vulpen  
Hoogglanzend acryl  
Gediamanteerd beslag  
van verguld metaal  
Met veiligheidsdop voor  
convertersysteem

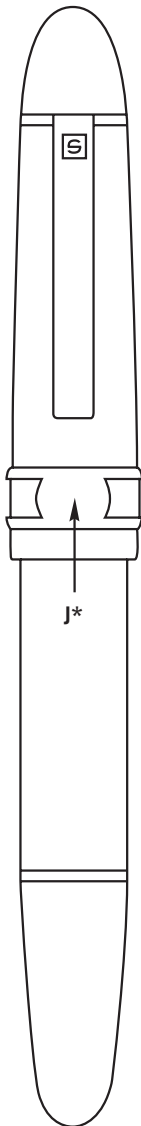

**5512 PRESIDENT Set**

Kolbenfüllhalter  
0125 im Etui

Piston filling fountain pen  
0125 in case

Stylo à plume à piston  
0125 présentés en étui

Converter vulpen  
0125 in etui



**5674 PRESIDENT Set**

Kolbenfüllhalter 0122  
in edler Präsentbox  
inklusive Tintenfass  
mit blauer Tinte

Piston filling fountain  
pen 0122 presented in  
premium gift box, includes  
bottle of blue ink

Stylo à plume à piston  
0122 en boîte cadeau  
avec flacon d'encre  
bleu roi.

Converter vulpen 0122  
in geschenkverpakking  
inclusief inktpotje met  
blauwe inkt



- \* Initialiengravur
- \* initial engraving
- \* gravure des initiales
- \* Graving van de initialen

# PRESIDENT



## SPECIAL FEATURE:

- > überwiegend in Handarbeit gefertigtes Tintenleitsystem
- > Hand-made ink feeder system.
- > conduction d'encre avec système de sécurité
- > Overwegend handgemaakt inktgeleidesysteem



### 0122 PRESIDENT

KOLBENFÜLLHALTER  
Große, fein ziselierte und platinveredelte Schreibfeder aus 18 kt. Gold (F, M)

PISTON FILLING FOUNTAIN PEN  
Large, finely embellished platinum-finished writing nib of 18 ct. gold (F, M)

STYLO A PLUME A PISTON  
large plume en or 18 ct. plaqué et finement ciselée (F, M).

CONVERTER VULPEN  
Grote, fijn versierde en met platina veredelde schrijfpunt van 18 karaats goud (F, M)

### 0125 PRESIDENT

KOLBENFÜLLHALTER  
Große, fein ziselierte Bicolor-Schreibfeder aus Edelstahl mit Iridiumspitze (F, M, B)

PISTON FILLING FOUNTAIN PEN  
Large, finely embellished bi-colour iridium tipped stainless steel nib (F, M, B)

STYLO A PLUME À PISTON  
large plume en acier inoxydable bicolore finement ciselée (F, M, B)

CONVERTER VULPEN  
Grote, fijn bewerkte bicolor schrijfpunt met iridium punt (F, M, B)

# ETUIS · CASES · ETUIS · VERPAKKINGEN

D

Praktische Aufbewahrungsbox, kleine Aufmerksamkeit oder edle Hülle. SENATOR bietet für jeden Anlass die richtige Verpackung.

GB

A little something, a functional case or a noble gift box, SENATOR offers a case for every purpose.

F

Soit un petit quelque chose pour votre client soit un étui pratique soit une gaine noble. Pour chaque opportunité SENATOR vous offre l'emballage approprié.

NL

Een praktische opbergbox, kleine attentie of hoogwaardig etui. SENATOR heeft voor iedere gelegenheid de juiste verpakking.



## ET 150 Etui

Leder  
schwarz  
mit Einstecklasche  
für 2 Schreibgeräte  
**Prägefläche:**  
ca. 22 x 25 mm

## ET 150 Wallet

Black leather wallet  
Loop closure for two  
writing instruments  
**Printing area:**  
approx. 22 x 25 mm

## ET 150 Etui

en cuir,  
noir,  
avec languette de  
fermeture. 2 places.  
**Surface de marquage :**  
ca. 22 x 25 mm

## ET 150 Etui

Leder  
Zwart met gescheiden  
ruimte om 2 stuks  
schrijfwaren in te steken.  
**Drukformaat:**  
ca. 22 x 25 mm



## ET 154 Etui

Kunststoff  
schwarz-silber  
transparenter Deckel  
Für 1 Schreibgerät  
Auch für schlanke  
Schreibgeräte: ET 154 A  
**Druckfläche:**  
50 x 10 mm

## ET 154 Case

Black/Silver case  
Transparent lid  
Suitable for 1  
writing instrument  
Also available for slim  
writing instruments:  
ET 154A  
**Printing area:**  
50 x 10 mm

## ET 154 Etui

Plastique,  
noir et argent,  
couvercle transparent,  
1 place. Aussi disponible  
pour des instruments  
d'écriture étroits (ET154A)  
**Surface de marquage :**  
50 x 10 mm

## ET 154 Etui

Zwart/zilverkleurig met  
transparant deksel.  
Voor 1 schrijfinstrument.  
Ook voor dunne  
schrijfwaren (ET154A)  
**Drukformaat:**  
50 x 10 mm

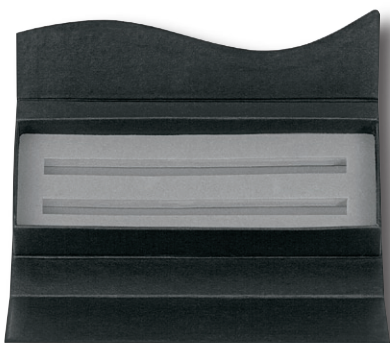

## ET 156 Etui

Karton  
matt schwarz  
graue Schaumstoffeinlage  
mit Magnetverschluss  
für 1 oder 2 Schreibgeräte  
**Druckfläche:**  
50 x 20 mm

## ET 156 Case

Black carded case  
Magnetic closure and  
foam inlay  
For 1 or 2 writing  
instruments  
**Printing area:**  
50 x 20 mm

## ET 156 Etui

Couleur noire mat,  
intérieure en mousse gris.  
1 ou 2 places. Avec  
fermoir magnétique.  
**Surface de marquage :**  
50 x 20 mm

## ET 156 Etui

Karton  
Mat zwart met grijze inlay.  
Voor 1 of 2  
schrijfinstrumenten.  
**Drukformaat:**  
50 x 20 mm



## ET 157 Etui

Karton  
matt schwarz  
für 1 Schreibgerät  
**Druckfläche:**  
auf Anfrage

## ET 157 Wallet

Matt black carded sleeve  
For 1 writing instrument.  
**Printing area:**  
on request

## ET 157 Etui

Carton,  
noir mat,  
1 place.  
**Surface de marquage :**  
sur demande.

## ET 157 Etui

Karton  
Mat zwarte verpakking.  
Voor 1 schrijfinstrument.  
**Drukformaat:**  
op aanvraag

ab 5.000 Stück auch  
in anderen Farben  
individualisierbar

At 5,000 pcs. also  
available in different  
colours

A partir de 5.000 pièces  
aussi disponible en d'autre  
couleurs.

vanaf 5.000 stuks ook  
in andere kleuren te  
realiseren.



---

**ET 160 Etui**

Lederoptik  
schwarz  
hellgraue Velourseinlage  
für 1 oder 2 Schreibgeräte  
**Druckfläche:**  
50 x 20 mm

---

**ET 160 Case**

Black leather look case  
Light grey velour lining  
For 1 or 2 writing  
instruments.  
**Printing area:**  
50 x 20 mm

---

**ET 160 Etui**

Aspect cuir,  
noir,  
avec intérieur gansé  
velours gris clair.  
1 ou 2 places. Avec  
fermoir magnétique.  
**Surface de marquage :**  
50 x 20 mm

---

**ET 160 Etui**

Kunstleder  
Zwart met grijze inleg.  
Voor 1 of 2  
schrijfinstrumenten.  
**Drukformaat:**  
50 x 20 mm

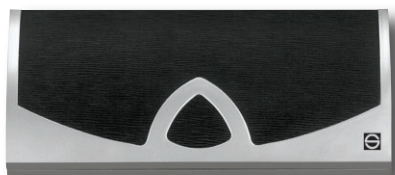

---

**ET 163 Etui**

Metall  
schwarz/silber  
dekorativer Deckel  
schwarze Velourseinlage  
für 1 oder 2 Schreibgeräte  
**Druckfläche:**  
25 x 8 mm

---

**ET 163 Case**

Black/silver metal case  
Decorative lid,  
black velour lining.  
For 1 or 2 writing  
instruments.  
**Printing area:**  
25 x 8 mm

---

**ET 163 Etui**

Métal  
Couleur noir/argent,  
couvercle décorative.  
Intérieur gansé velours noir.  
1 ou 2 places.  
**Surface de marquage :**  
25 x 8 mm

---

**ET 163 Etui**

Metaal  
Zwart/zilverkleurig  
met zwarte velours inleg.  
Voor 1 of 2  
schrijfinstrumenten.  
**Drukformaat:**  
25 x 8 mm



---

**ET 168 Etui**

Exklusive Präsentbox  
schwarzer Hochglanzlack  
edle Innenauskleidung  
inkl. Tintenfass mit blauer  
Tinte  
für 1 Kolbenfüllhalter  
President

---

**ET 168 Exclusive gift box**

Gift box in black high  
gloss finish  
Includes 1 x blue ink bottle.  
Custom made for the  
piston filling President  
fountain pen

---

**ET 168 Etui**

Boîte représentative avec  
 finition laqué brillant, inté-  
rieur noble. Flacon d'encre  
bleu roi. Pour 1 stylo à  
plume President.

---

**ET 168 Etui**

Zwarte, hoogglanzende  
geschenkverpakking met  
inleg, inclusief inktpotje  
met blauwe inkt voor  
de converter vulpen  
President.



---

**ET 169 Etui**

Kunststoff  
glänzend transparent  
universelle Halterung für  
Schreibgerät und Deckel  
für 1 Schreibgerät  
**Druckfläche:**  
125 x 12 mm

---

**ET 169 Case**

Transparent plastic case  
with universal pen holder.  
For 1 writing instrument.  
**Printing area:**  
125 x 12 mm

---

**ET 169 Etui**

En plastique brillant et  
transparent.  
Avec support universel pour  
stylo et couvercle. 1 place.  
**Surface de marquage :**  
125 x 12 mm

---

**ET 169 Etui**

Kunststoff  
glänzend transparant  
met deksel en  
universele klem voor 1  
schrijfinstrument.  
**Drukformaat:**  
125 x 12 mm



---

**ET 171 Etui**

Kunststoff  
glänzend transparent  
universelle Halterung für  
Schreibgerät und Deckel  
für 2 Schreibgeräte  
**Druckfläche:**  
25 x 60 mm

---

**ET 171 Case**

Transparent plastic case  
with universal pen holder.  
For 2 writing instruments.  
**Printing area:**  
25 x 60 mm

---

**ET 171 Etui**

En plastique brillant et  
transparent.  
Avec support universel pour  
stylo et couvercle. 2 places.  
**Surface de marquage :**  
25 x 60 mm

---

**ET 171 Etui**

Kunststoff  
glänzend transparant  
met deksel en  
universele klem voor 2  
schrijfinstrumenten.  
**Drukformaat:**  
25 x 60 mm

# TECHNIK · TECHNIQUE · TECHNIQUE · TECHNIËK

D	GB	F	NL
<b>Beeindruckend</b>	<b>Impressive</b>	<b>Impressionnante</b>	<b>Indrukwekkend</b>
Mit den hier dargestellten Veredelungstechniken lassen sich Marken, Unternehmen und Werbebotschaften vielseitig und wirkungsvoll inszenieren.	The customisation possibilities illustrated provide a range of ideas for effective branding.	Les possibilités de finition ici représentées permettent la mise en scène variée et efficace des marques, entreprises et messages publicitaires.	Met de hier afgebeelde veredelingsstechnieken maken merken, bedrijven en reclameboodschappen veelzijdig en met succes indruk.



**A**  
SCREEN  
PRINT

Siebdruck	Screen Print	Sérigraphie	Zeefdruk
Die gängigste Druckart für die Bedruckung von Schreibgeräten. Besonders scharf und detailliert, mehrfarbig möglich, auf Innenröllchen 1 - 2 farbig.	The most common technique used for branding writing instruments. Ideal for multi-coloured logos. Results: good colour laydown, precise detail.	Cette technique est la plus courante pour l'impression des instruments d'écriture de manière précise et détaillée. Les tubes intérieurs peuvent être imprimés jusqu'à 2 couleurs.	De meest gangbare druktechniek voor het bedrukken van balpennen. Uitermate scherp en gedetailleerd, meerkleurendruk mogelijk, tekstrolletjes in maximaal 2 kleuren.



**B**  
HEAT  
PRINT

Einbrenndruck	Heat print	Impression cuit	Ingebrande druk
Bei diesem Druckverfahren wird die Spezialdruckfarbe in die Metalloberfläche dauerhaft eingebrannt. Mehrfarbdruck ab 500 Stück möglich.	In this process, colour is burnt on to the surface of the metal surface. Multi-colour prints are also possible from 5,000 units.	Dans ce procédé d'impression, la couleur d'impression spécial est brûlée dans la surface métallique. Impression multichrome possible à partir de 500 pièces.	Bij deze druktechniek wordt de bedrukking in het oppervlak van het metaal ingebrand. Meerkleurenbedrukking is mogelijk vanaf 500 stuks.



**C**  
TAMPO  
PRINT

Tampondruck	Tampo Print	Tampographie	Tampondruk
Dieses indirekte Druckverfahren eignet sich besonders für die Bedruckung geschwungener Oberflächen wie unsere Clipse. Mehrfarbig möglich.	Please replace with: Ideal for printing on uneven surfaces such as curved clips. Multi-colour logos also possible.	Cette technique d'impression indirecte se prête bien à l'impression des surfaces recourbées comme des clips.	Deze druktechniek is ideaal voor het bedrukken van niet-vlakke of voor zeefdruk moeilijke te bereiken oppervlakken, zoals de (gebogen) clips van balpennen.



**D**  
360°  
PRINT

#### 360° Druck

Alle mit diesem Logo gekennzeichneten Schreibgeräte können 1- bis 5-farbig 360° rundum bedruckt werden.

Auch fotorealistische Drucke sind möglich.

#### 360° Print

The entire surface of the barrel can be used for maximum branding effect. Photo realistic and multi-coloured branding can be achieved.

#### 360° Wrap Around

Cette technique permet d'imprimer à 360° sur toute leur surface les instruments d'écriture de une à cinque couleurs.

Des impressions de photos sont également possibles.

#### 360° druk

Alle pennen waarbij dit logo is afgebeeld kunnen in 1 tot 5 kleuren 360° rondom worden bedrukt.

Ook fotorealistische bedrukkingen zijn mogelijk.



**E**  
DIGITAL  
PRINT

#### Digitaldruck

Detailgenaue Foto-Drucke und Farbverläufe lassen sich mit diesem Druckverfahren auf dem Akzent-Clip eindrucksvoll in hoher Auflösung realisieren.

#### Digital Print

This process applies detailed photo realistic imprints and colour gradients on to the Akzent clip.

#### Impression numérique

Ce procédé d'impression permet de réaliser des impressions photo aux détails précis et des fondus de couleurs de manière impressionnante et avec une résolution élevée sur le clip Akzent.

#### Digitale druk

Gedetailleerde fotodruk en kleurverlopen kunnen met dit drukprocédé op de Akzent-clip indrukwekkend in hoge resolutie gerealiseerd worden.

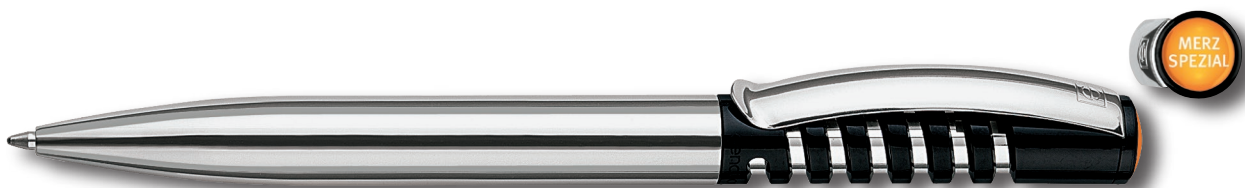

**G**  
LOGO  
PRINT

#### Logo Print

Der SENATOR Logo-Print ist ein computergestütztes Druckverfahren mit verblüffendem 3-D-Effekt und hervorragender Brillanz.

#### Logo Print

The SENATOR Logo-Print service is a computer-assisted printing process with 3-D effects, and outstanding brilliance.

#### Logo Print

Le Logo Print Service de SENATOR est un procédé d'impression à effet 3D d'un brillant excellent.

#### Logo Print

De SENATOR Logo-Print service is een computergestuurde druktechniek met verbluffend 3-D-effect en grote scherpste.



**H**  
METAL  
PRINT

#### Metalldruck

Spezialdruckfarben sorgen für eine besondere Haltbarkeit auf Metalloberflächen. Auch für Etuis geeignet.

#### Metal Print

Special printing colours are used for the print on metal writing instruments and cases.

#### Impression metallographique

Pour ce procédé d'impression nous employons des encres spéciales pour imprimer des instruments d'écriture en métal et des étuis.

#### Drukken op metaal

Speciale inkten garanderen bijzonder goede houdbaarheid op metalen oppervlakken. Ook geschikt voor etuis.

# TECHNIK · TECHNIQUE · TECHNIQUE · TECHNIËK



I

ETCHING

## Ätzung

Die Ätzung ist eine sehr haltbare Werbeanbringung mittels chemischer Behandlung auf nicht lackierten Metalloberflächen. Sie erscheint leicht bräunlich.

## Etching

Etching is the chemical treatment of non-lacquered metallic surfaces for long-lasting branding (with a slight brown colour appearance).

## Impression à l'eau forte

Traitement chimique des surfaces métalliques (légèrement brunes).

## Etsing

Etsing is het op een zeer duurzame manier aanbrennen van een logo, waarbij een ongelakt metalen oppervlak chemisch behandeld wordt. Het resultaat wordt grijs-bruin.



K

CHEMO PRINT

## Chemo Print

Ihre Werbebotschaft rundum und absolut dauerhaft auf edlem Aluminium. Bis zu 3-farbig möglich, auch silber- und gold-glänzend.

## Chemo Print

Your advertising message reproduced on a high shine aluminium, all around the barrel.

## Chemo Print

Votre message sur toute la surface en aluminium. Jusqu'à 3 couleurs possibles, aussi en couleur or ou argent.

## Chemo Print

Duurzame hoogwaardige reclame rondom op edel aluminium. Mogelijk tot 3 kleuren, ook glanzend zilver- en goudkleurig.

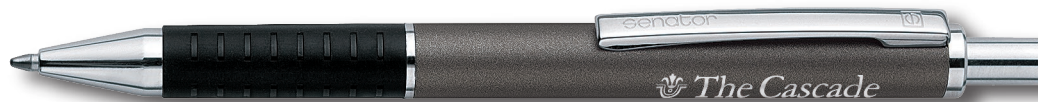

J

LASER ENGRAVING

## Lasergravur

Die Lasergravur ist eine absolut haltbare und präzise Werbeanbringung. 15 Schriften stehen zur Auswahl (siehe Abbildung), auch Einzelnamengravuren sind möglich.

Die Farbe der Gravur ist abhängig vom Material des Schreibgerätes.

## Laser engraving

Laser engraving is a durable and precise branding method. 15 standard typefaces are available (see illustration).

The colour of the engraving is dependant on the material of the pen.

## Gravure au laser

La gravure au laser est absolument durable. Vous pouvez choisir parmi 15 polices standard (selon illustration). La personnalisation à l'unité est également possible.

## Lasergravering





De SENATOR Lasergravering service is een absoluut blijvende reclame-uiting met een hoge mate van precisie. Keuze uit 15 standaard lettertypen (zie afbeelding), ook enkelnamensgravering is mogelijk.

De kleur van de gravering hangt af van het materiaal waarvan de pen gemaakt is.



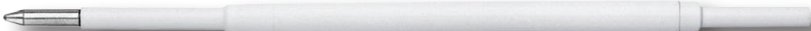
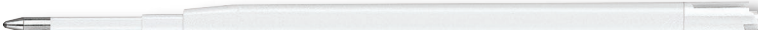

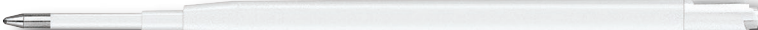
# MINEN · REFILLS · RECHARGES · VULLINGEN

D	GB	F	NL
Alle Minen von SENATOR sind problemlos austauschbar und im Handel erhältlich.	All SENATOR refills can be exchanged and replaced after usage.	Les recharges SENATOR respectent les mesures conformément aux normes en vigueur et sont ainsi disponible dans le commerce.	Alle vullingen van SENATOR zijn probleemloos te vervangen en in de detailhandel verkrijgbaar.
<b>8062</b>	<b>8062</b>	<b>8062</b>	<b>8062</b>
<b>Qualitätsmine</b> Format X20 dokumentenecht gemäß ISO 1257-2	<b>Quality refill,</b> Format X20, document-quality to ISO 12757-2	<b>Recharge de qualité,</b> format X20 conforme à la documentation selon l'ISO 12757-2	<b>Kwaliteitsvulling</b> Formaat X20 geproduceerd volgens ISO 12757-2
			
<b>8063</b>	<b>8063</b>	<b>8063</b>	<b>8063</b>
<b>Qualitätsmine</b> Format X20 Jumbo dokumentenecht gemäß ISO 1257-2	<b>Quality refill,</b> Format X20 Jumbo, document-quality to ISO 12757-2	<b>Recharge de qualité,</b> format X20 Jumbo conforme à la documentation selon l'ISO 12757-2	<b>Kwaliteitsvulling</b> Formaat X20 Jumbo geproduceerd volgens ISO 12757-2
			
<b>8004</b>	<b>8004</b>	<b>8004</b>	<b>8004</b>
<b>Qualitäts-Großraummine</b> Format G2 dokumentenecht gemäß ISO 1257-2	<b>Qualitäts-Quality jumbo refill,</b> Format G2, document-quality to ISO 12757-2	<b>Recharge à grande capacité et de qualité,</b> format G2 conforme à la documentation selon l'ISO 12757-2	<b>Kwaliteits-langschrijfvulling</b> Formaat G2 geproduceerd volgens ISO 12757-2
			
<b>8068</b>	<b>8068</b>	<b>8068</b>	<b>8068</b>
<b>Qualitäts-Metall-Großraummine</b> Format G2 dokumentenecht gemäß ISO 1257-2	<b>Quality metal jumbo refill,</b> Format G2, document-quality to ISO 12757-2	<b>Recharge de qualité de grande capacité , en métal,</b> format G2 conforme à la documentation selon l'ISO 12757-2	<b>Metalen kwaliteitsvulling (langschrijfvulling),</b> Formaat G2 geproduceerd volgens ISO 12757-2
			
<b>1906</b>	<b>1906</b>	<b>1906</b>	<b>1906</b>
<b>Gel-Mine</b> Format G2 Strichstärke 0,7 mm	<b>Gel refill,</b> Format G2, line width 0.7 mm.	<b>Recharge à base de gel,</b> format G2 épaisseur du trait 0,7 mm.	<b>Gel-vulling</b> Formaat G2 lijndikte 0,7 mm.
			
<b>1904</b>	<b>1904</b>	<b>1904</b>	<b>1904</b>
<b>Metall Rollerball-Mine</b> Format gemäß ISO 14145 Strichbreite ca. 0,6 mm	<b>Metal rollerball refill,</b> Format to ISO 14145, line width approx. 0.6 mm	<b>Rollerball métallique,</b> format selon l'ISO 14145, largeur de trait env. 0,6 mm	<b>Metalen rollerball-vulling</b> Formaat volgens ISO 14145 lijndikte ca. 0,6 mm
			
<b>1916</b>	<b>1916</b>	<b>1916</b>	<b>1916</b>
<b>Kunststoff Rollerball-Mine</b> Format gemäß ISO 14145 Strichbreite ca. 0,6 mm	<b>Plastic rollerball refill,</b> Format to ISO 14145, line width approx. 0.6 mm	<b>Rollerball plastique,</b> format selon l'ISO 14145, largeur de trait env. 0,6 mm	<b>Kunststof rollerball-vulling,</b> Formaat volgens ISO 14145, lijndikte ca. 0,6 mm
			



# ICC INDIVIDUAL COLOUR CONCEPT

D

## Beeindruckend

Grenzenlose Farbmöglichkeiten bereits ab 5.000 Stück in jeder beliebigen PMS Farbe (Volltonfarbe) möglich

Die Lieferung für Aufträge von 5.000 bis 20.000 Stück erfolgt ca. 3 Wochen nach Auftragsklarheit und Vorlage aller benötigten Unterlagen.

Gerne bieten wir Ihnen weitere Schreibgeräte in individueller Färbung ein. Fragen Sie zu Angebot und Mindestmenge bitte Ihren Kundenberater.

GB

## Strikingly individual advertising!

The ICC service offers you limitless colour possibilities and the realisation of tailor-made individual advertising concepts. From a quantity of 5,000 pieces, the SENATOR Dart or the SENATOR Akzento Basic can be produced in any PMS colour required (spot colour)! A mix of standard colours is also possible.

We will be pleased to offer further writing instrument models in individual colours. Ask your SENATOR customer consultant about a quotation and minimum quantities.

F

## Une publicité personnalisée à l'extrême !

Le service ICC vous propose des possibilités illimitées en termes de couleur et la réalisation de concepts publicitaires sur mesure et personnalisés. Dès 5 000 pièces, le SENATOR Dart ou le SENATOR Basic peuvent être produits dans une couleur PMS de votre choix (nuancer pantone)!

Nous vous offrons volontier d'autres instruments d'écriture dans des couleurs individuelles. Veuillez demander une offre et les quantités minimales à votre conseiller clientèle SENATOR.

NL

## Opvallende reclame

De ICC-Service biedt u grenzeloze kleur-mogelijkheden en de realisering van op maat gemaakte, individuele reclameconcepten. Al vanaf 5.000 stuks kan de SENATOR Dart of de SENATOR Akzento Basic in elke gewenste PMS-kleur (opake kleuren) geproduceerd worden! Ook een combinatie met een standaardkleur is mogelijk.

De levertijd voor opdrachten van 5.000 tot 20.000 stuks is circa 3 weken na vrijgave van alle benodigde informatie. Hogere aantallen op aanvraag.



ICC DART

ICC DART

ICC DART

ICC DART



ICC AKZENTO

ICC AKZENTO

ICC AKZENTO

ICC AKZENTO



**D****Farboptionen**

Der unten aufgeführten Tabelle können Sie unsere Kunststofffarben entnehmen. Da die Papierfarben und die Kunststofffarben unterschiedlich sind, stimmen die angegebenen Farbtöne nicht 100%ig mit unseren Kunststofffarben überein. Diese Angaben sollen nur als Richtwerte verstanden werden. Um sicher zu sein, fordern Sie bitte ein Muster in der gewünschten Farbe an.

**TRANSPARENTE KUNSTSTOFF FARBEN**

PMS 116 C

**TRANSLUCENT PLASTIC COLOURS**

PMS 1225 C

**COULEURS PLASTIQUE OPAQUE**

PMS 1505 C

**TRANSPARENTE KUNSTSTOFF-KLEUREN**

PMS 201 C



PMS rodamine red C



PMS 267 C



PMS 281 C



PMS 286 C



PMS 313 C



PMS 339 C



PMS 3425 C



PMS 347 C



PMS 368 C



PMS 416 C



PMS 418 C



icy

**GB****Colour options**

The table below illustrates our plastic colours. As paper colours and plastic colours are different, the colours indicated therein are for reference only and may not match our plastic colours 100%. Therefore our indication are to be understood as reference values only. To be sure on the exact colour shade, please ask for a sample in the requested colour.

**OPAQUE KUNSTSTOFF FARBEN**

PMS 116 C

**OPAQUE PLASTIC COLOURS**

PMS 123 C

**COULEURS PLASTIQUE OPAQUE**

PMS 144 C

**OPAQUE KUNSTSTOFF-KLEUREN**

PMS 151 C



PMS 188 C



PMS 226 C



PMS rhodamine red C



PMS 268 C



PMS 2728 C



PMS 281 C



PMS 285 C



PMS 2935 C



PMS 288 C



PMS 341 C



PMS 3435 C



PMS 349 C



PMS 390 C



PMS 429 C



PMS 485 C



black



white



natural

**F****Options de couleurs**

Vous pouvez consulter nos couleurs sur plastique sur le tableau présenté ci-dessous. Etant donné que les couleurs sur papier et les couleurs sur plastique sont différentes, les nuances indiquées ne concordent pas à 100% avec nos couleurs sur plastique. Ces indications doivent être comprises comme des valeurs de référence. Pour plus de sûreté, demandez svp un échantillon dans la couleur souhaitée.

**NL****MOGELIJKE KLEUREN**

In onderstaande tabel ziet u voor de artikelen met welke PMS-kleuren onze kleurcodes overeenkomen. Omdat kleuren op papier anders tonen dan kunststofkleuren, komen de aangegeven kleuren niet altijd 100% met de kunststofkleuren overeen. De tabel moet u dan ook als een richtlijn beschouwen. Vraagt u bij twijfel een monster in de gewenste kleur aan.

**METALLISCHE KUNSTSTOFF FARBEN**

PMS 1817 C

**METALLIC PLASTIC COLOURS**

PMS 3305 C

**COULEURS PLASTIQUE METALLIQUE**

PMS 423 C

**METALLIC KUNSTSTOFF-KLEUREN**

PMS 432 C



PMS 648 C



PMS 652 C



black



pearl



PMS 877 C

	<u>D</u>	<u>GB</u>	<u>F</u>	<u>NL</u>
<b>A</b> SCREEN PRINT	Siebdruck	Screen print	Sérigraphie	Zeefdruk
<b>B</b> HEAT PRINT	Einbrenn- druck	Heat print	Impression séchée au four	Inbrand- druk
<b>C</b> TAMPO PRINT	Tampon- druck	Tampo print	Tampographie	Tampon- druk
<b>D</b> 360° PRINT	360° Rundum- druck	360° Wrap-Around print	360° Impression tout autour	360° Wrap-Around print
<b>E</b> DIGITAL PRINT	Digitaldruck	Digital print	Impression digitale	Digitale druk
<b>G</b> LOGO PRINT	Logo-Print	Logo-Print	Logo-Print	Logo-Print
<b>H</b> METAL PRINT	Druck auf Metall / Etui	Print on metal / case	Impression sur métal / étui	Drukken op metaal
<b>I</b> ETCHING	Ätzung	Etching	Traitement chimique	Etsing
<b>J</b> LASER ENGRAVING	Laser- gravur	Laser engraving	Gravure au laser	Laser- graving
<b>K</b> CHEMO PRINT	Chemo Print	Chemo Print	Chemo Print	Chemo Print
<b>P</b> CLIP 4U FEATURE	Individueller Clip	Individual clip	Clip individuel	Custom-made clip
<b>COLOUR MIX PEN</b>	Individueller Farbmix	Individual Colour Mix	Combinaisons de couleurs individuelles	Individuele kleurcom- binatie
<b>GEL OPTION</b>	Gel Option	Gel option	Option Gel	Gel Option

**INHALT NACH  
ARTIKELNUMMER**

**CONTENTS  
BY ITEM NO.**

**CONTENU  
PAR NO. ART.**

**INHOUD NAAR  
ARTIKELNUMMER**

**NEU !**

**NEW !**

**NOUVEAU !**

**NIEUW !**

0104  
Image Black  
79

1119  
Image Black  
79

2426  
New Spring  
Clear  
20

2431  
New Spring  
Chrome  
18

2561  
New Spring  
Chrome Clear  
19

2645  
Antibac Pen  
40-41

2721  
Matrix Classic  
16

2736  
Skeye Icy  
29

2739  
Skeye XL Alu  
29

2788  
Legacy  
75

2850  
Super Hit  
Eco  
12

6205  
Image Black  
78

6206  
Image Black  
78

0031	Delgado Classic	69
0032	Delgado Classic	69
0033	Delgado Metallic	71
0039	Delgado Steel	71
0056	Visir	73
0073	Image Classic	77
0075	Image Chrome	79
0076	Carbon Line	85
0122	President	89
0125	President	89
0240	Tizio	83
1029	Delgado Classic	69
1030	Delgado Classic	69
1031	Delgado Metallic	71
1036	Image Chrome	79
1037	Carbon Line	85
1039	Delgado Steel	71
1056	Visir	73
1079	Silver Line	87
1092	Nautic	74
1133	Big Pen	32
1133C	Big Pen Colour Mix	33
1143	Solaris	81
1160	Image Classic	77
1171C	Big Message Pen	34
1177	Big Pen Icy	30
1177C	Big Pen Icy Colour Mix	31
1240	Tizio	83
1479	Solaris Chrome	80
2040	Softstar Steel	65
2067	Soft-Spring	25
2122	Duo-Pen	24
2156	Hatrix Basic Colour Mix	38
2158	Image Chrome	79
2159	Carbon Line	85
2160	Image Classic	77
2177	Hatrix Basic	39
2178	Hatrix Soft	39
2179	Hatrix Metal	36
2215	Nautic	74
2234	Super-Soft Clear	57
2239	Delgado Classic	69
2240	Delgado Classic	69
2241	Delgado Metallic	71
2242	Delgado Steel	71
2244	Super-Hit Icy	59
2253	Visir	73
2274	Super-Soft Basic	56
2303	New Spring Basic	22
2310	New Spring Metallic	23
2318	Matrix Basic	17
2319	Matrix Clear	17
2321	Matrix Metallic	17
2331	Super-Hit Icy Colour Mix	58
2339	Hatrix Soft Clear	37
2362	Point Basic	55
2379	Silver Line	87
2400	Tizio	83
2410	New Spring Clear	21
2416	Challenger Basic	48
2417	Challenger Soft	44
2418	Challenger Icy	47
2419	Hatrix Metal Clear	37
2427	Solaris	81
2474	Challenger Icy Colour Mix	47
2479	Solaris Chrome	80
2511	Softstar Alu	65
2512	@tract Basic	15
2513	@tract Metal	14
2519	Challenger Alu	49
2590	Point Plus	55
2597	Challenger Soft Clear	45
2600	Dart Basic	63
2602	Dart Clear	63
2636	Image Black	77
2725	Sunny Basic	60
2726	Sunny Clear	61
2732	Skeye Clear	26
2733	Skeye XL Clear	27
2734	Skeye Basic	28
2760	Akzento Icy	50
2762	Akzento Basic	52
2763	Akzento Icy (Clip 4 You)	51
2764	Akzento Basic (Clip 4 You)	53
2766	Akzento Icy Colour Mix	50
2796	Nature Plus	13
2866	Point Metal	54
2883	Super-Hit Basic	59
2925	Challenger XL Clear	42
2926	Challenger XL Metallic	43
3004	Softstar Steel	67
3111	Softstar Alu	67
3179	Silver Line	87
5512	President	88
5674	President	88
6089	Image Chrome	78
6095	Set Delgado Classic	68
6096	Set Delgado Classic	68
6097	Set Delgado Metallic	70
6100	Set Delgado Classic	68
6101	Set Delgado Classic	68
6102	Set Delgado Metallic	70
6104	Set Delgado Steel	70
6114	Set Delgado Steel	70
6117	Set Image Chrome	78
6163	Set Silver Line	86
6164	Set Silver Line	86
6178	Set Solaris	81
6193	Set Visir	72
6194	Set Visir	72
6201	Set Image Classic	76
6202	Set Image Classic	76
6203	Set Image Classic	76
6204	Set Image Classic	76
6237	Set Image Chrome	78
6238	Set Image Chrome	78
6239	Set Carbon Line	84
6240	Set Carbon Line	84
6252	Set Tizio	82
6253	Set Tizio	82
6341	Set Softstar Steel	67
6342	Set Softstar Alu	67
6480	Set Solaris Chrome	80



designed to brand